

GNSS CALIBRATION REPORT

G1G2_1011_2020

Prepared by: Andreas Bauch (PTB)
Head, Time Dissemination
Working Group

Approved by: Jürgen Becker (PTB)
QM-representative of
Time and Frequency
Department of PTB

Authorized by: BIPM

Project: PTB_G1G2_ORB_ESTEC
Code: 1011_2020
Version: 1.2
Safe date: 07.10.2020 09:14

TABLE OF CONTENTS

LIST OF TABLES AND FIGURES	3
REFERENCES	4
ACRONYMS.....	5
EXECUTIVE SUMMARY.....	6
1. CONTENTS OF THE REPORT.....	7
1.1. CHANGE LOG.....	7
2. PARTICIPANTS AND SCHEDULE	9
3. CALIBRATION PROCEDURE.....	10
3.1. GENERAL DESCRIPTION.....	10
3.2. DETERMINATION OF DELAYS OF GALILEO SIGNALS	12
4. CHARACTERIZATION OF PTB EQUIPMENT	14
5. RESULTS OF COMMON-CLOCK SET-UP IN PTB: PERIOD 1	17
6. OPERATION OF PTBT AT ORB.....	19
6.1. CALIBRATION OF RECEIVER BRUX.....	21
6.2. CALIBRATION OF ORBA	22
6.3. CALIBRATION OF GRCA	22
6.4. CALIBRATION OF RECEIVER RTBS.....	22
6.5. SUMMARY OF RESULTS OBTAINED AT ORB	23
7. OPERATION OF PTBT AT PTB: SECOND PERIOD	24
7.1. SUMMARY	25
8. INT DLY UNCERTAINTY EVALUATION	26
9. FINAL RESULTS.....	29
ANNEX: BIPM CALIBRATION INFORMATION SHEETS.....	31

LIST OF TABLES AND FIGURES

Table 2-1: List of participants.....	9
Table 2-2: Schedule of the campaign	9
Table 6-1 Δ INT DLY(Π) values and statistical properties (in ns) obtained initially.....	23
Table 7-1: Result of common clock measurements at PTB.....	25
Table 8-1: Uncertainty contributions for the calibration of receiver delays.....	27
Table 9-1. Results of the Calibration Campaign G1G2_1011_2020: GPS delays, all values in ns.....	29
Table 9-2. Results of the Calibration Campaign G1G2_1011_2020: Galileo delays, all values in ns ...	30
Figure 4-1: Common-clock common-view GPS comparison between PT13 and PT09 receivers at PTB during campaign 1011-2020; thick lines: daily mean values, thin lines: maximum and minimum value (16-min average) during the respective day.....	14
Figure 4-2: UTC(PTB) reference point and 1 PPS signal distribution to PT13, PTBT, and other receivers;	15
Figure 4-3: UTC(PTB) signal distribution (5 MHz, 10 MHz, 20 MHz) to PT13, PTBT, and other receivers	16
Figure 4-4: Installation of GNSS antennas at PTB, PT13 antenna (yellow) and PTBM antenna position during CC1 indicated (orange)	16
Figure 5-1: Left: Corrections to GPS delay in PTBM during CC1, Δ P1 (dark green) and Δ P2 (light green) values obtained; Right: Corrections to Galileo delays in PTBM during CC1, Δ E1 (black) and Δ E5a (red).	17
Figure 5-2: TDEV obtained for the four data sets shown in Figure 5-1, GPS (upper row), Galileo (lower row).....	17
Figure 6-1 Signal distribution at ORB to the receivers.....	19
Figure 6-2: PTMB antenna mounted at ORB.....	20
Figure 6-3: Temperature in the receiver room at ORB.....	20
Figure 6-4: External temperature (orange) and humidity (blue) at ORB during the campaign	21
Figure 6-5. Corrections to INT DLY in BRUX, reference PTBM; left: GPS Δ P1 (brown) and Δ P2 (orange), right: Galileo, Δ E1 (black) and Δ E5a (red).....	21
Figure 6-6. Left: Corrections to INT DLY in ORBA, reference PTBM; left: GPS Δ P1 (dark) and Δ P2 (light), right: Galileo, Δ E1 (brown) and Δ E5a (dark yellow).	22
Figure 6-7. Corrections to INT DLY in GRCB, reference PTBM; left: GPS Δ P1 (dark) and Δ P2 (light), right: Galileo, Δ E1 (dark) and Δ E5a (light).	22
Figure 6-8. TOT DLY in RTBS, reference PTBM; left: GPS Δ P1 (dark) and Δ P2 (light), right: Galileo, Δ E1 (dark green) and Δ E5a (light green).....	23
Figure 7-1. Δ Pi values obtained during the second common-clock set-up in PTB.....	24
Figure 7-2. TDEV obtained for the four data sets shown in Figure 7-1, GPS (upper row) and Galileo (lower row).	24

REFERENCES

REFERENCES	
RD01	BIPM report 2018 Group 1 GPS calibration trip 1001-2018_GPSP3C1_Group1-trip_V1-3
RD02	BIPM guidelines for GNSS calibration, V3.0, 02/04/2015
RD03	BIPM TM.212 (G. Petit), Nov. 2012
RD04	J. Kouba, P. Heroux, 2002, " <i>Precise Point Positioning Using IGS Orbit and Clock Products</i> ," GPS Solutions, Vol 5, No. 2, 12-28
RD05	W. Lewandowski, C. Thomas, 1991, " <i>GPS Time transfers</i> ," Proc. IEEE, Vol. 79, No. 7, 991-1000
RD06	PTB GNSS calibration report G1G2_1012_2016
RD07	P. Defraigne and G. Petit, "CGGTTS-Version 2E: an extended standard for GNSS time transfer, Metrologia 52 (2015) G1
RD08	Defraigne, P., Aerts, W., Cerretto, G., Cantoni, E., and Sleewaegen, J.-M., "Calibration of Galileo signals for time metrology," IEEE Trans. Ultrason. Ferroelect. Freq. Contr., vol. 61, no. 12, 2014, pp. 1967-1975.
RD09	Piriz, R., Rodriguez, D., Roldan, P., Mudrak, A., Bauch, A., Leute, J., Pánek, P., and Kuna, A., "Relative Calibration of Galileo Receivers within the Time Validation Facility (TVF)," Proc. 2015 Joint Conference of the IEEE International Frequency Control Symposium & European Frequency and Time Forum, 12-16 Apr 2015, Denver, Colorado, USA, pp. 245-249, 2015
RD10	Buist, P., Mozo, A., and Tork, H., "Overview of the Galileo Reference Centre: Mission, Architecture and Operational Concept," Proc. Of the ION GNSS+, Portland, OR, September 2017.
RD11	BIPM / GP Continuity of GNSS "INTDLY" values of Group 1 geodetic receivers in successive Group 1 trips, TM 266 V2.5 19 June 2020.
RD12	PTB Report GNSS CALIBRATION REPORT PT13 VIA 1001-2018, 01 September 2020

ACRONYMS

ACRONYMS	
BIPM	Bureau International de Poids et Mesures, Sèvres, France
CGGTTS	CCTF Generic GNSS Time Transfer Standard
ESA	European Space Agency
EURAMET	The European Association of National Metrology Institutes
IGS	International GNSS Service
GNSS	Global Navigation Satellite System
ORB	Observatoire Royal Belgique
PPP	Precise Point Positioning
PTB	Physikalisch-Technische Bundesanstalt, Braunschweig, Germany
RINEX	Receiver Independent Exchange Format
R2CGGTTS	RINEX-to CGGTTS conversion software, provided by ORB / BIPM
TDEV	Time deviation
TIC	Time interval counter

EXECUTIVE SUMMARY

As part of the support of the BIPM Time and Frequency Group by EURAMET G1 laboratories, PTB conducted a relative calibration of the GNSS equipment of ORB, Belgium, with respect to the calibration of PTB receiver PT13, which currently serves as the reference receiver in all GPS dual-frequency time links to PTB in the context of realization of TAI. Its delays were determined with respect to receiver PT09 which in turn got its last calibration from BIPM as reported with Cal_Id=1001-2018 [RD01]. PTB provided its receiver PTBM for the purpose as travelling equipment.

The current campaign followed as much as possible the BIPM Guide [RD02] and results will be reported using Cal_Id 1011_2020. Primary results provided are the visited receiver's internal delays for GPS P-code signals on the two frequencies L1 and L2 (INT DLY (P1), and INT DLY(P2)). The delays for the C/A-code signals on L1 were also determined during this campaign using PT13 as the reference. With the same method, the signal delays for Galileo E1 and E5a which are relevant for the use of Galileo signals in a ionosphere-free linear combination were determined. Initially, PT13 Galileo delays had been determined with reference to receiver GRCP. With publication of V2 of [RD01] and V2.5 of [RD11] in June 2020, Galileo delay values for the G1 laboratories were published. In case of PTB, values for PT09 were provided. Subsequently, the Galileo delay values of PT13 were aligned using the same method as in 2019 and reported in [RD12]. In retrospect, Galileo delays of ORB receivers have been corrected as reported in this version 1.2 of the report.

The final results are included in Table 9-1 and Table 9-2. The internal delays of the two receivers involved were determined with an uncertainty of about 1 ns for single frequency observations. The uncertainty for time transfer links to PTB evaluated in a ionosphere-free linear combination is less than 1.2 ns in all cases.

As a reminder: All uncertainty values reported in this document are 1- σ values.

PTB quality management responsables gave the advice to stress in this report that the correctness of all results and of the stated uncertainty values relies partially on the correctness of the entries in the installation report (BIPM information tables) provided by the visited institute.

1. CONTENTS OF THE REPORT

As part of the support of the BIPM Time and Frequency Group by EURAMET G1 laboratories, PTB conducted a relative calibration of the GNSS equipment of ORB, Belgium with respect to the calibration of PTB receiver PT13, which currently serves as the reference receiver in all GPS dual-frequency time links to PTB in the context of realization of TAI. Its delays were determined with respect to receiver PT09 which in turn got its last calibration from BIPM as reported with Cal_Id=1001-2018 [RD01]. PTB provided its receiver PTBM for the purpose as travelling equipment.

This report documents the installation, data taking and evaluation during the campaign.

The determination of the internal delay values of the receiver at the visited site is a three-step process.

At first (Common-Clock 1, CC1), the travelling receiver, PTBM, was compared to the “golden” receiver, PT13, and the offset between the actual and the assumed PTBM delay values were determined.

After that, the receiver was installed at the visited sites and the internal delay values of the devices under test and their statistical properties were determined with respect to PTBM.

Finally, the stability of the PTBM delays was assessed by a second Common-Clock measurement (CC2) in PTB. Based thereon, the “final” INT DLY values of the visited receivers and their uncertainty values were calculated.

The structure of this report follows this sequence of work. After presentation of the participants and schedule, a general section follows that contains the (mathematical) calibration procedure, followed by a report of data collection at PTB and ORB. The final results and the uncertainty discussion close the report. In the Annex the BIPM information tables are reproduced.

1.1. CHANGE LOG

Version	Date	Changes
1.0	28.05.2020	Version 1, all new
1.1	09.06.2020	Entries in Table 9-1 corrected: values for receivers BRUX and ORBA had been incorrect Fig. 7.1 improved (wrong header corrected) PTB report sheets improved, notes clarified
1.2	05.10.2020	Update of Galileo delay values for ORB receivers

2. PARTICIPANTS AND SCHEDULE

Table 2-1: List of participants

Institute	Point of contact	Site address
PTB	Thomas Polewka Tel +49 531 592 4418 Thomas.polewka@ptb.de	PTB, AG 4.42 Bundesallee 100 38116 Braunschweig, Germany
ORB	Pascale Defraigne Tel. +32(0)23730260 p.defraigne@oma.be	Royal Observatory of Belgium Avenue Circulaire, 3 B-1180 Brussels Belgium

Table 2-2: Schedule of the campaign

Date	Institute	Action	Remarks
2020-01- 28 until 2020-02-03	PTB	First common-clock comparison between PTBTM and PT13	7 days used for determination of delays, MJD 58876 – 58882
2020-04-02 Until2020-04-05	ORB	Operation of PTBM in parallel with four receivers	4 days used for determination of delays, MJD 58941 - 58944
2020-05-20 until 2020-05-25	PTB	Operation of PTBM after return	6 days used for determination of delays, 58989 - 58994

Due to the restrictions imposed by authorities because of the Covid-19 pandemia, the receiver had to stay at ORB for an extended period before dismantling and shipping was allowed.

Information on the receivers at each site is contained in individual information tables which can be found in the Annex.

3. CALIBRATION PROCEDURE

3.1. GENERAL DESCRIPTION

The calculation of INT DLY values for the receiver to be calibrated follows the description given in BIPM TM.212 [RD03] and has been coded in a software routine written by Egle Staliuniene of PTB. The following text piece that describes its function is generated via copy-paste from [RD03] with small changes of the designation of quantities.

When dealing with G1G2 calibrations, in principal we distinguish receivers V, T, and G: V for visited, T for travelling, and G for golden_reference. G1 labs committed to ship their T to the other sites. In the current campaign, PT13 (named PTBB when referred to as IGS station) serves as the reference receiver G. Its delays were determined with respect to receiver PT09 which in turn got its last calibration from BIPM as reported with Cal_Id=1001-2018 [RD01]. PTBM served as the travelling receiver T, and this was the first campaign involving the new set-up.

Conventionally, the receiver delay D is considered as the sum of different terms that are defined subsequently:

(1) INT DLY

The sum $X_R + X_S$ represents the "INT DLY" field in the CGGTTS header:

X_R represents the receiver hardware delay, between a reference point whose definition depends on the receiver type and the internal time reference of the measurements. X_S represents the antenna delay, between the phase center and the antenna cable connector at the antenna body. We distinguish the two quantities for the two frequencies, 1 and 2.

INT DLY(P1) and INT DLY(P2) of receiver V are the basic quantities that are determined during the relative calibration. For calculating ionosphere-free observation data, INT DLY(P3) is calculated as $2.54 \times \text{INT DLY}(P1) - 1.54 \times \text{INT DLY}(P2)$.

The following terms are considered frequency independent, i. e. no distinction is made for P1 and P2 and other signal frequencies.

(2) CAB DLY

The sum $X_C + X_D$ represents the "CAB DLY" field in the CGGTTS header.

X_C corresponds to the delay of the long cable from the antenna to the input connector at either the antenna splitter or the receiver body directly. If a splitter is installed, X_D corresponds to the delay of the splitter and the small cable up to the receiver body. For a simple set-up with just an antenna cable, $X_D = 0$.

(3) REF DLY

The sum $X_P + X_O$ represents the "REF DLY" field in the CGGTTS header.

X_P corresponds to the delay of the cable between the laboratory reference point for local UTC and the 1 PPS-in connector of the receiver.

X_0 corresponds to the delay between the 1PPS-in connector and the receiver internal reference point, the latter depending on the receiver type:

- For Septentrio PolaRx4: The 1 PPS-out, no further correction
- For Septentrio PolaRx5TR: optionally X_0 is determined autonomously by the receiver or it can be determined alike to the PolaRx4.
- For DICOM GTR50 and GTR51: The 1PPS-in, i.e. $X_0 = 0$,
- For TTS-4: RD02, Section 2.3.2, and Annex G specify the procedure for TTS-4, which in detail depends on the software version.

PT13 (PolaRx5TR) had been installed in April 2019, and the auto-calibration option was disabled. PTBM (PolaRx5TR) makes use of the auto-calibration option.

The distinction of the individual components of the receiver delay reflects the fact that two of them, 2 and 3, can in principle be measured with standard laboratory equipment. Changes of the receiver installation typically affect cabling and thus such delays.

The quantity to be determined by the relative calibration is INT DLY. INT DLY of the device under test is determined in such a way that the common-clock differences obtained between the device under test and the reference are zero on average. The INT DLY of T may need to be adjusted so that T and G match, but in practice the small correction needed is taken into account only when INT DLY of V is adjusted to G, using T as intermediate for the measurements made at the different sites.

In the process followed by PTB, valid CGGTTS files with dual frequency observation (L3P) data (including correct, accurate antenna coordinates) are needed. As a reminder,

$$\text{REFGPS}(k) = [\text{REFGPS}_{\text{RAW}}(k) - \text{CAB DLY}_F - \text{INT DLY}(P3) + \text{REF DLY}_F], \quad (1)$$

where REFGPS(k) is reported in column 10 of the standard CGGTTS files, $\text{REFGPS}_{\text{RAW}}$ designates the uncorrected measurement values, INT DLY(P3) is calculated as $2.54 \times \text{INT DLY}(P1)_F - 1.54 \times \text{INT DLY}(P2)_F$, and the values designated as " Q_F " are reported in the CGGTTS file header.

The ionospheric delay for a signal at frequency f is proportional to $1/f^2$. According to [RD07], the column MDIO in CGGTTS V2E files contains the measured ionospheric delay for the higher of the two combined frequencies. The delay for the other frequency is thus $\text{MDIO} \times (f_1/f_2)^2$. The software cv.py in calibration mode thus calculates:

$$\text{REFGPS}_{P1}(j) = \text{REFGPS}(j) + \text{MDIO}(j) \quad (2a)$$

$$\text{REFGPS}_{P2}(j) = \text{REFGPS}(j) + (f_1/f_2)^2 \times \text{MDIO}(j), \quad (2b)$$

where $(f_1/f_2)^2 = 1.647$ for GPS for each satellite observation j and REFGPS(j) and MDIO(j) are from the line in the CGGTTS file that reports the observation j .

If the common-view condition is fulfilled for the observations with T and G, the differences

$$\Delta P_i = \text{REFGPS}_{P_i}(T) - \text{REFGPS}_{P_i}(G) \quad (3)$$

are calculated and represent the difference $P_i(\text{new}) - P_i(\text{old})$ for receiver T. The example here involves T and G: Equivalent relations hold for the pair of receivers T and V.

cv.py at the end of the computation edits the median value of all individual observations ΔP_i for P1 and P2, and the number of data points used. In addition cv.py generates a file `deltap_stats` that contains observation epoch (MJD.frakt) and the average ΔP_1 , ΔP_2 of all satellite observations at that epoch. Such values are plotted throughout the report in the various figures.

The calculation of the INT DLY values comprises two steps:

$$\text{Step 1: INT DLY}(P_i)_T\text{-corr} = \Delta P_i(T,G) + \text{INT DLY}(P_i)_T\text{-old}, \quad (4)$$

where the last summand $>_{\text{old}} <$ is the value reported in the CGGTTS file up to now.

Step 2: The final results for receiver V is to be calculated as

$$\text{INT DLY}(P_i)_V\text{-new} = \Delta P_i(V,T) + \langle \Delta P_i(T,G) \rangle + \text{INT DLY}(P_i)_V\text{-old}, \quad (5)$$

where $\langle \Delta P_i(T,G) \rangle$ is the mean value obtained during CC1 and CC2. Another option would have been to adjust the INT DLY of receiver T after CC1, but this was not done.

The third summand in (5) on the right represents the INT DLY value that was reported previously in the CGGTTS file of receiver V. In some cases this value may be reported initially as zero.

3.2. DETERMINATION OF DELAYS OF GALILEO SIGNALS

The above procedure has been used with minor modifications to transfer known delays for Galileo signals from one receiver to a second one. The main change in coding of software is the modification of the frequency ratio in eq. 2b to the Galileo signal frequencies, $(f_1/f_2)^2 = 1.794$ for Galileo. In all equations above, the acronym P_i could be replaced by E_i . The two Galileo frequencies considered are E1 and E5a.

The method of obtaining Galileo signal delays was published in [RD08] and later adapted by GMV in the context of work in various Galileo projects under contract with ESA and European Commission [RD09]. In May 2018 (Day 137 – 142 of 2018), the delays for GPS and Galileo signals of a new receiver for an installation at PTB as part of the Galileo Reference Center [RD10] were determined in a consistent fashion, using the PTB reference receiver at that time, PT02 (PTBB), for providing the GPS signal delays. The data from this receiver (acronym GRCP) are not public. After installation of PT13 as the new PTB reference receiver in April 2019, its Galileo signal delays were determined with reference to GRCP using data from Day 93 – 97 of year 2019.

With publication of V2 of [RD01] and V2.5 of [RD11] in June 2020, Galileo delay values for the G1 laboratories were published. In case of PTB, values for PT09 were provided. Subsequently,

the Galileo delay values of PT13 were aligned using the same method as in 2019 and reported in [RD12]. As a result, the PT13 delay for signals on E1 is larger by 1.0 ns, for signal on E5a by 1.2 ns. Galileo delays of ORB receivers have been corrected accordingly as reported in this version 1.2 of the report.

4. CHARACTERIZATION OF PTB EQUIPMENT

The assembly of receiver PTBM was finished quite recently . No long-term record can be provided. The stability of PT13 during the current campaign can be inferred from Figure 4-1 in which common-clock common-view comparisons to PT09, a Septentrio PolaRx4TR receiver are shown.

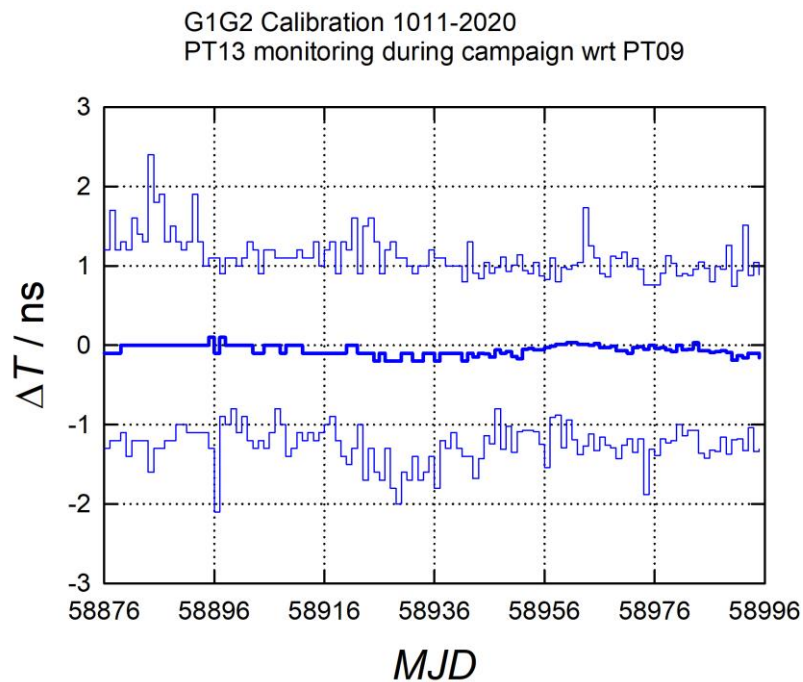

Figure 4-1: Common-clock common-view GPS comparison between PT13 and PT09 receivers at PTB during campaign 1011-2020; thick lines: daily mean values, thin lines: maximum and minimum value (16-min average) during the respective day.

The installation of the receivers in PTB is depicted in Figure 4-2 for 1 PPS signals and in Figure 4-3 for 5 MHz signals. The PT03 receiver was supplied with 20 MHz from a times 4 multiplier, but was decommissioned between start and end of the current campaign.

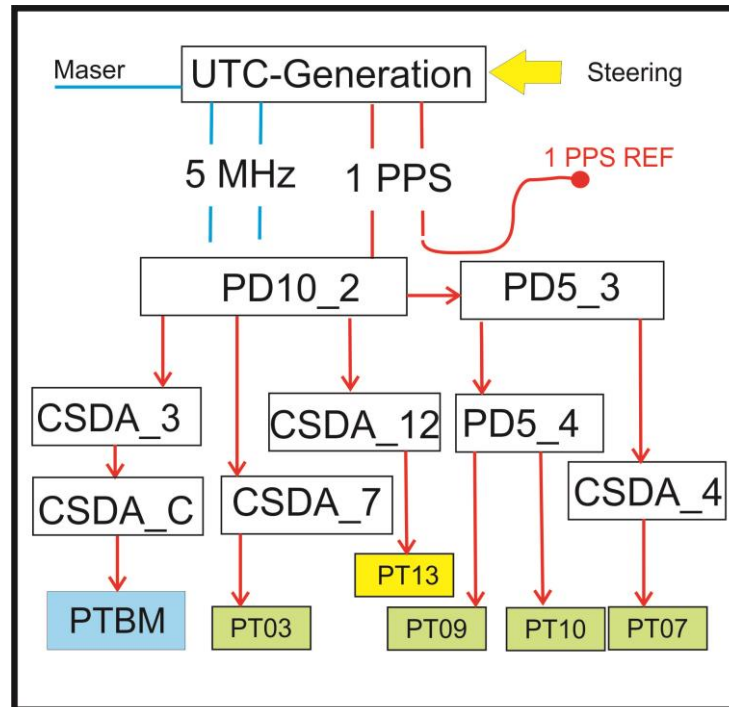

Figure 4-2: UTC(PTB) reference point and 1 PPS signal distribution to PT13, PTBT, and other receivers; PD10 stands for pulse distributor, CSDA stands for clock signal distribution amplifier

A clarification may be helpful regarding the 1 PPS REF point. When measuring with a TIC Port A = UTC(PTB), Port B = 1 PPS REF then the result is + 2.7 ns.

Figure 4-4 illustrates the installation of GNSS antennas on the roof of the PTB time laboratory (clock hall) during CC1.

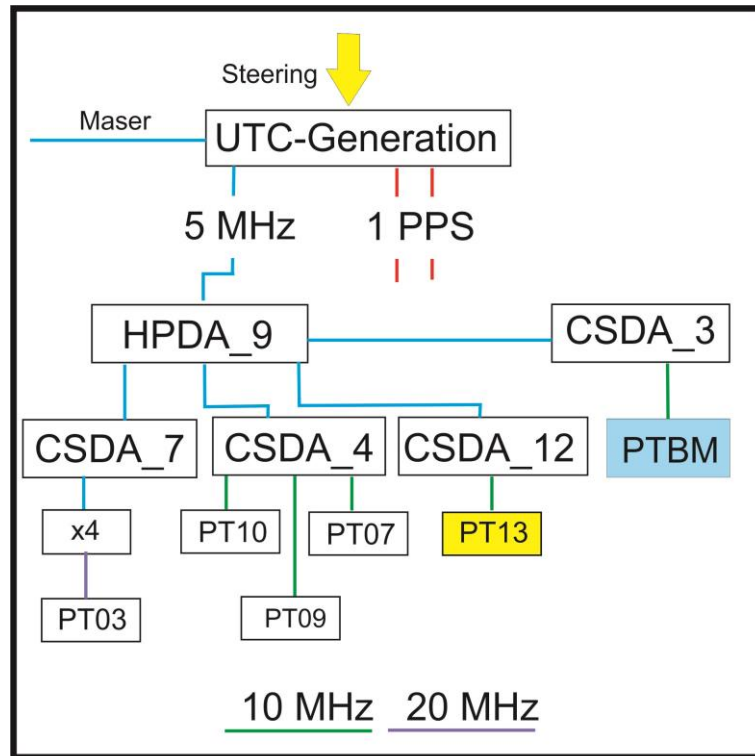

Figure 4-3: UTC(PTB) signal distribution (5 MHz, 10 MHz, 20 MHz) to PT13, PTBT, and other receivers
HPDA stands for High-precision distribution amplifier (for rf frequencies)

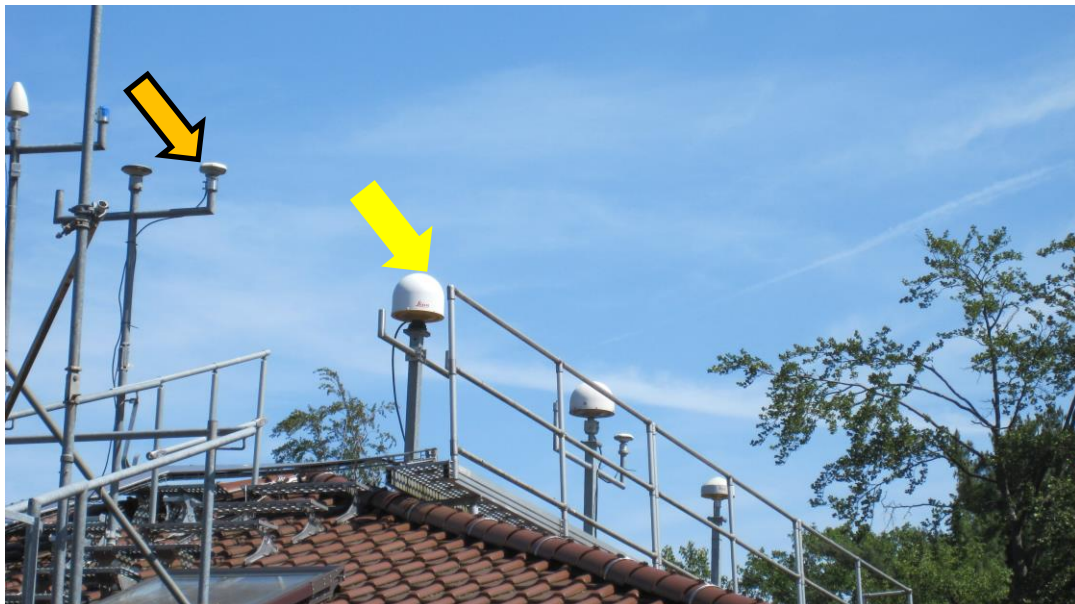

Figure 4-4: Installation of GNSS antennas at PTB, PT13 antenna (yellow) and PTBM antenna position during CC1 indicated (orange)

5. RESULTS OF COMMON-CLOCK SET-UP IN PTB: PERIOD 1

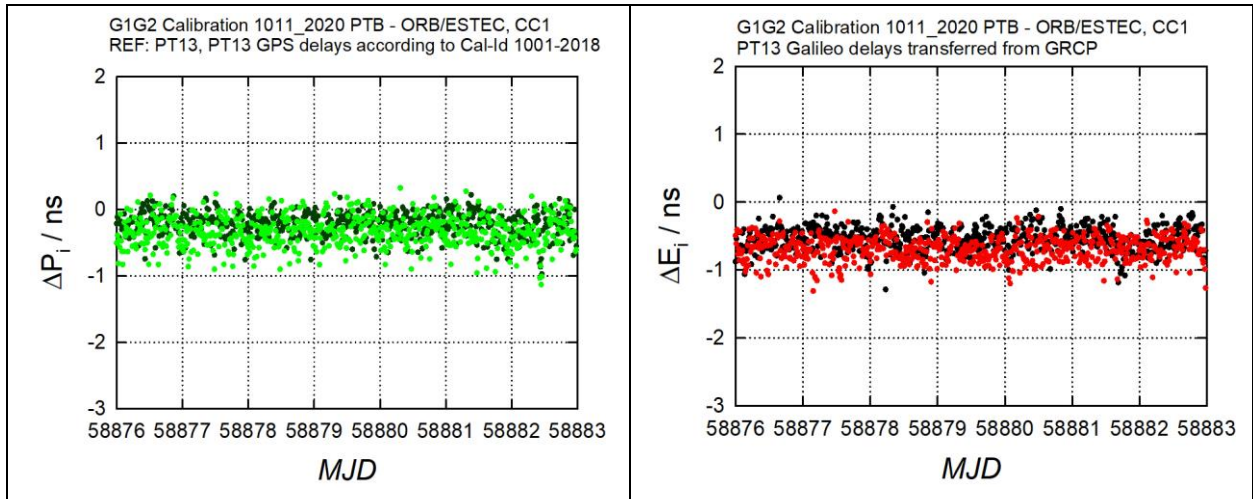

Figure 5-1: Left: Corrections to GPS delay in PTBM during CC1, ΔP_1 (dark green) and ΔP_2 (light green) values obtained; Right: Corrections to Galileo delays in PTBM during CC1, ΔE_1 (black) and ΔE_5a (red).

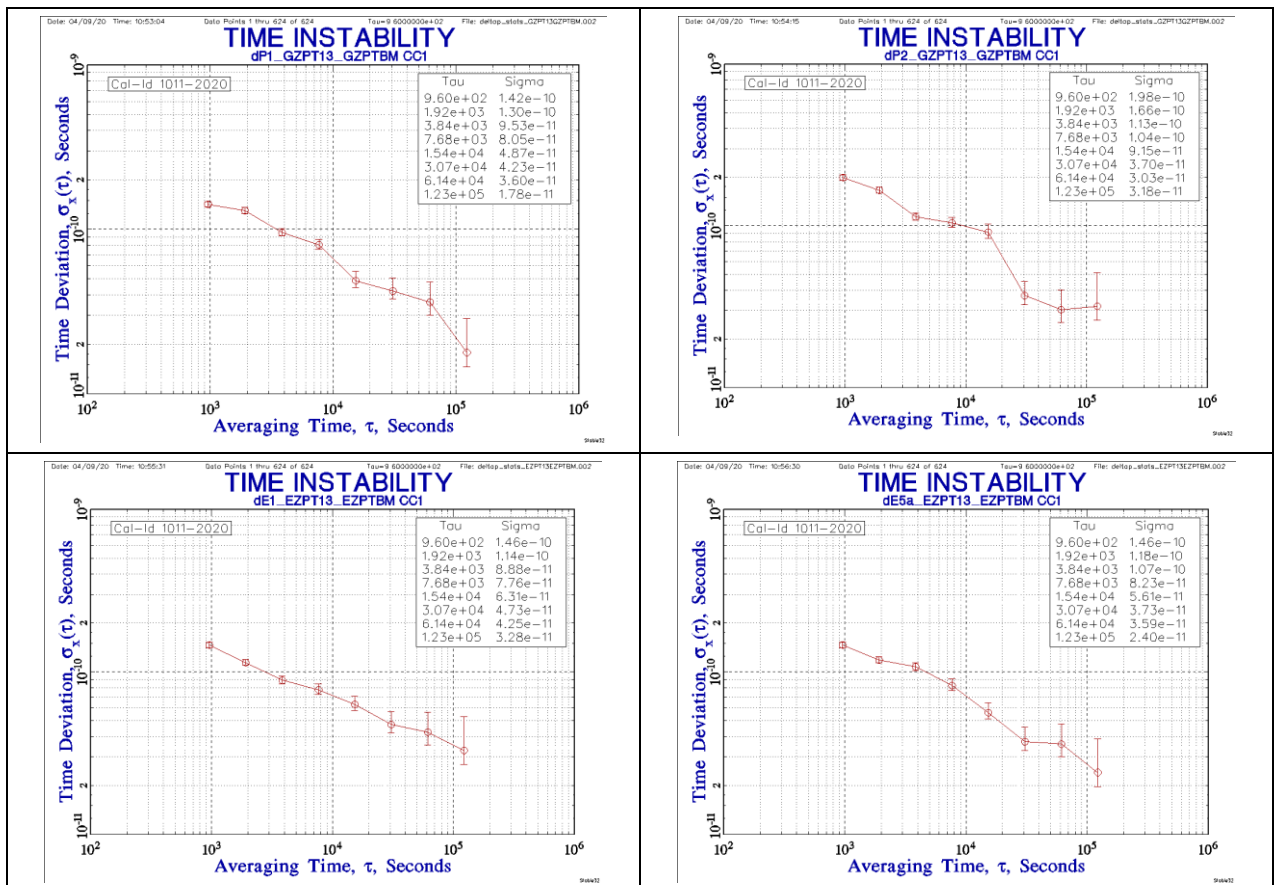

Figure 5-2: TDEV obtained for the four data sets shown in Figure 5-1, GPS (upper row), Galileo (lower row).

The period 58876 to 58883 (7 days) was chosen to determine the initial PTBT INT DLY values (CC1). The result of comparison with PT13 as the reference are shown in Figure 5-1 illustrating

in total 624 values obtained for each GNSS frequency as mean over all common view observations at a given epoch. The time instability (TDEV) plots for the two data sets follow as Figure 5-2. The numerical results are given in the Summary sub-section at the end of the report on CC2 in PTB.

The INT DLY(P_i) of PTBT have not been corrected for the offsets shown in Figure 5-1 before shipment. Instead, the individual value found for the visited receivers will be corrected for the mean value obtained after the second common-clock set-up (see eq. 5)). Please note that Figure 5-1 has not been updated wrt to the new PT13 Galileo delays.

6. OPERATION OF PTBT AT ORB

PTBM was operated at ORB between March and April 2020. Four days were used as the data base for the delay determination of the receivers BRUX, RTBS, GRCB and ORBA. The four-character code refers to the RINEX data of the receivers, whereas CGGTS files submitted to BIPM from receiver “BRUX” have the BIPM designation OR5Z. The BIPM designations are included in the report sheets in the Annex, throughout the Report the designations are used as seen also in Figure 6-1. The results are presented below. Details on the receivers and their installation are given in the Annex. The antenna positions were determined from analysis of RINEX data using the Atomium PPP software. The CGGTS files from PTBM and ORB receivers were reprocessed using r2cggts V 8.1.

The signal distribution to receivers PTBM, and ORB receivers is illustrated in Figure 6-1. All receivers were located in the ORB receiver laboratory. Receivers were powered from 220 VAC continuously. 1 PPS and 10 MHz signals were connected to the receivers with SMA connectors.

The mounting position of the PTBM antenna is shown in Figure 6-2.

The internal and external temperatures are shown in **Figure 6-3** and Figure 6-4.

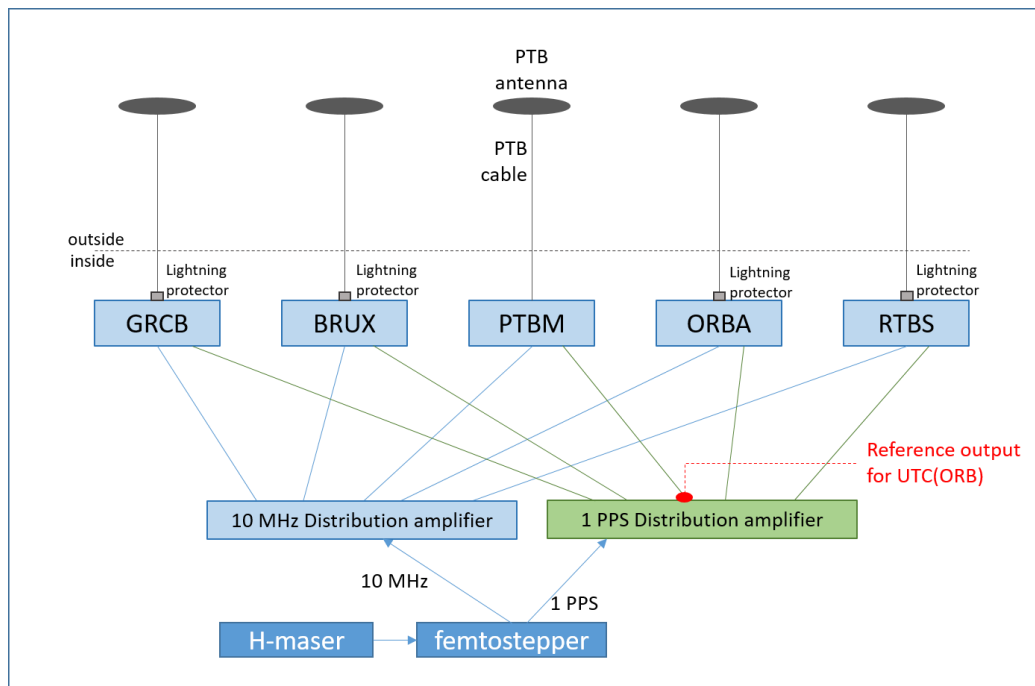

Figure 6-1 Signal distribution at ORB to the receivers

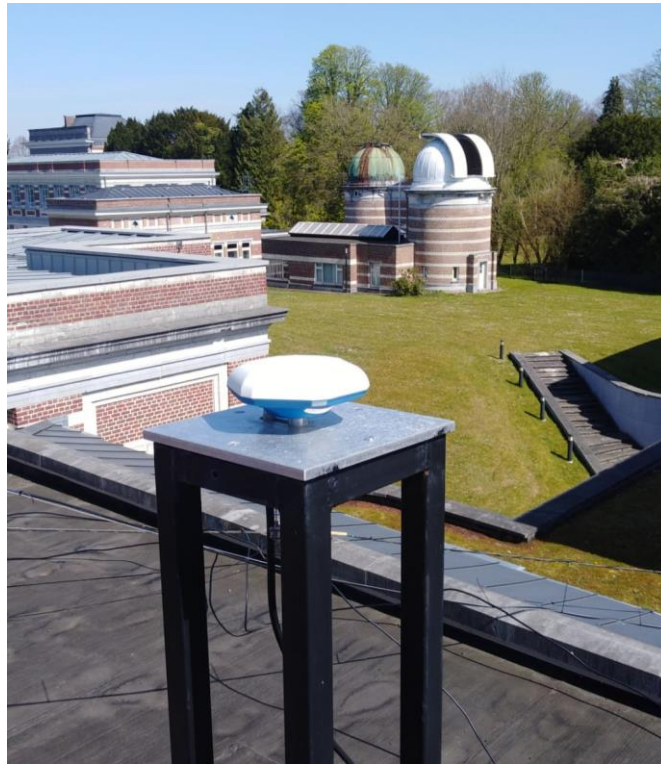

Figure 6-2: PTMB antenna mounted at ORB

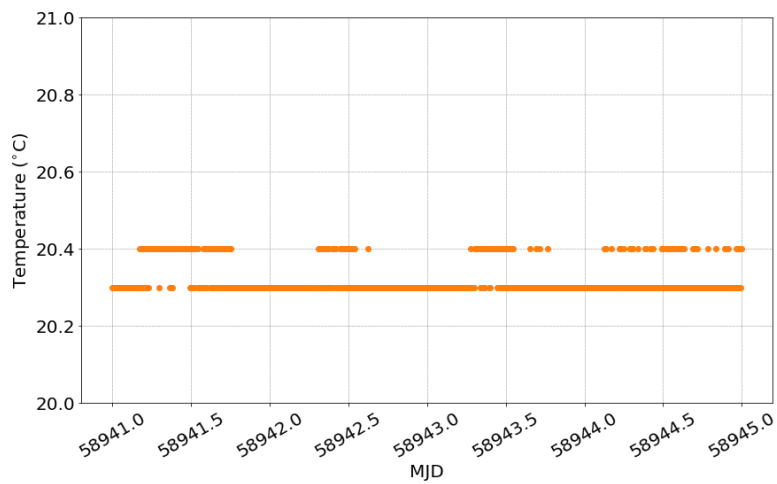

Figure 6-3: Temperature in the receiver room at ORB

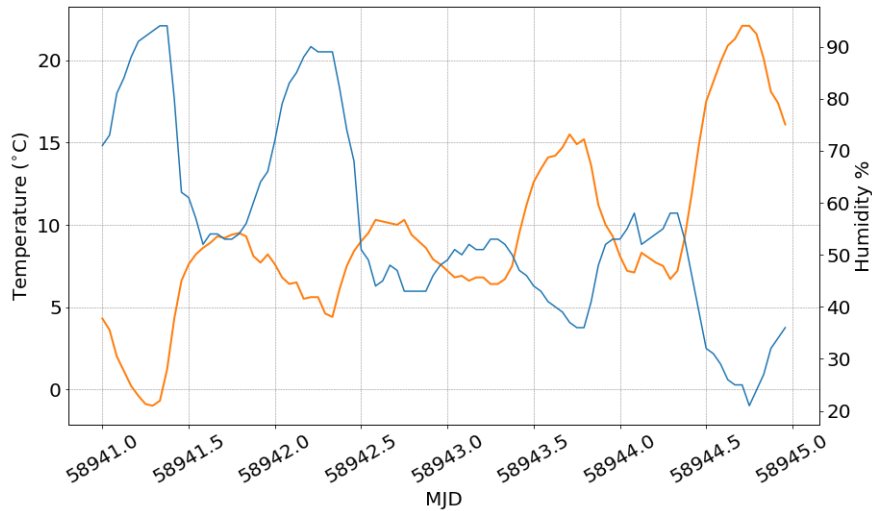

Figure 6-4: External temperature (orange) and humidity (blue) at ORB during the campaign

6.1. CALIBRATION OF RECEIVER BRUX

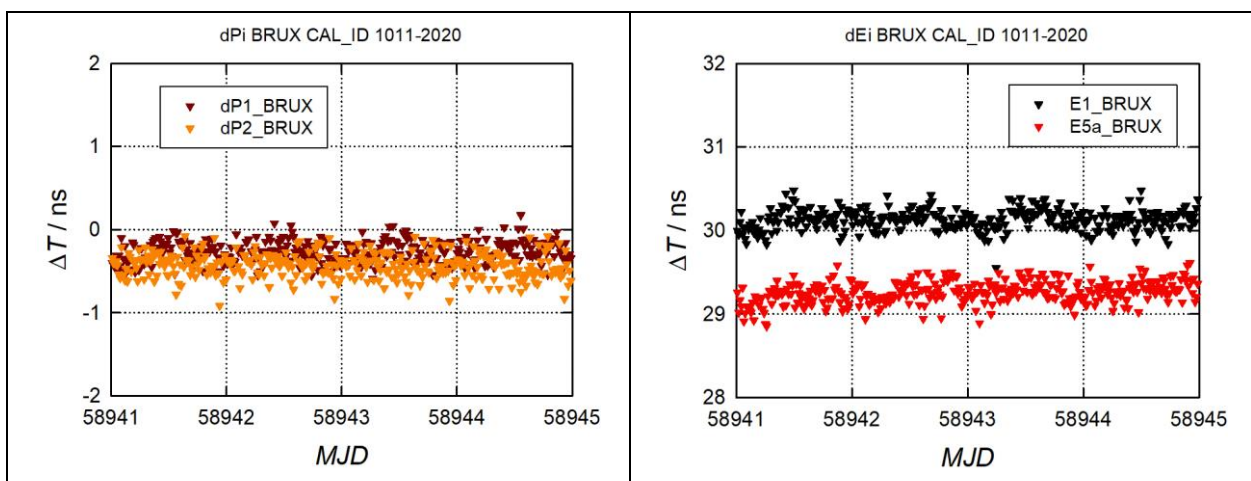

Figure 6-5. Corrections to INT DLY in BRUX, reference PTBM; left: GPS $\Delta P1$ (brown) and $\Delta P2$ (orange), right: Galileo, $\Delta E1$ (black) and $\Delta E5a$ (red).

In Figure 6-5 the ΔP_i (3) derived from the raw data are depicted. The results regarding all receivers are tabulated in Table 6-1 which contains the mean and the median value, the standard deviation of individual data points and an estimate for the statistical uncertainty which is derived from TDEV at $\approx 30\,000$ s. The default value of 0.1 ns is chosen if the measured TDEV is less than 0.1 ns. This practice is followed for all receivers.

6.2. CALIBRATION OF ORBA

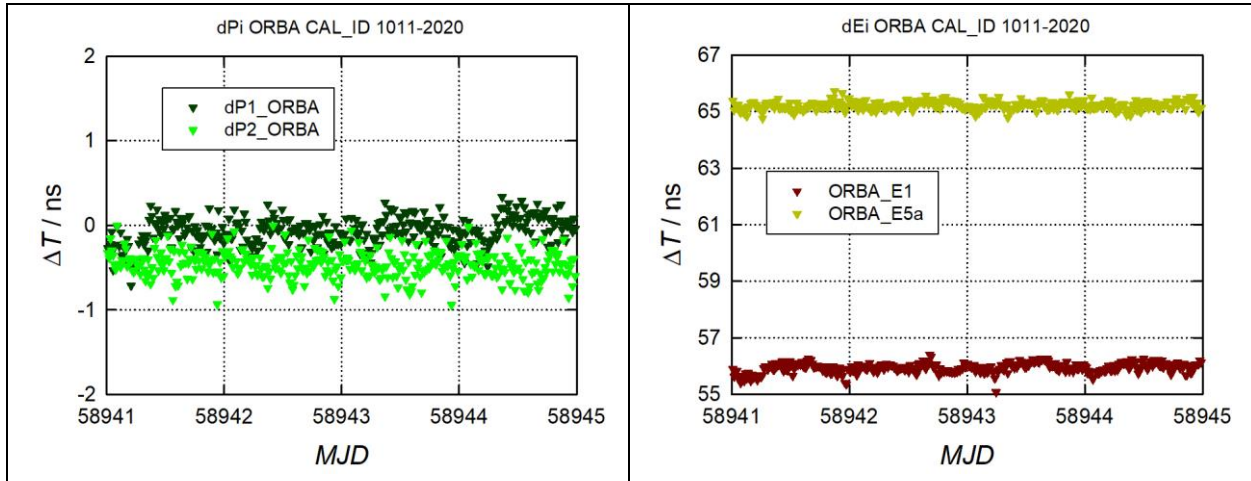

Figure 6-6. Left: Corrections to INT DLY in ORBA, reference PTBM; left: GPS $\Delta P1$ (dark) and $\Delta P2$ (light), right: Galileo, $\Delta E1$ (brown) and $\Delta E5a$ (dark yellow).

6.3. CALIBRATION OF GRCB

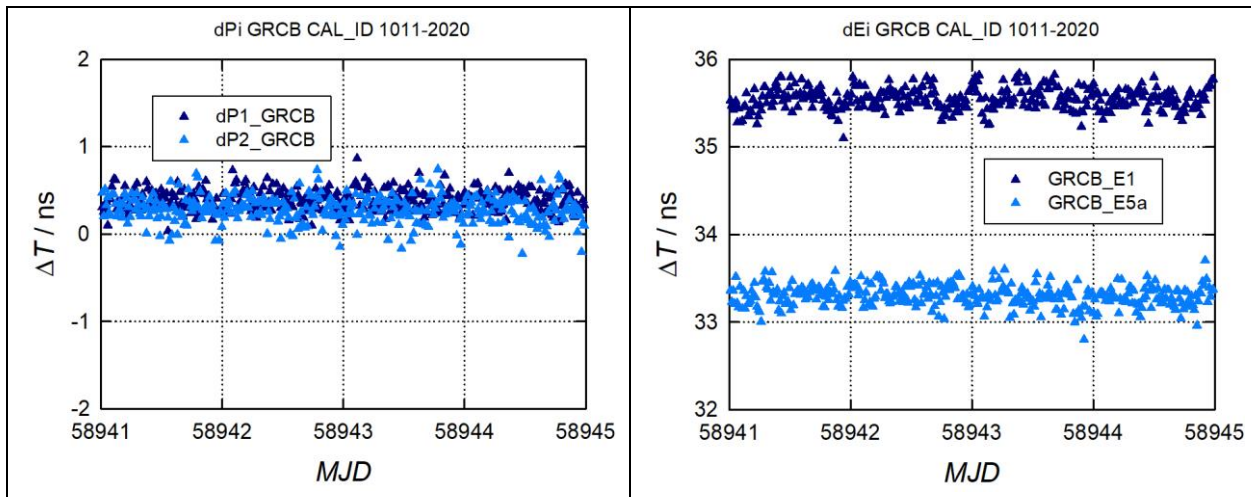

Figure 6-7. Corrections to INT DLY in GRCB, reference PTBM; left: GPS $\Delta P1$ (dark) and $\Delta P2$ (light), right: Galileo, $\Delta E1$ (dark) and $\Delta E5a$ (light).

6.4. CALIBRATION OF RECEIVER RTBS

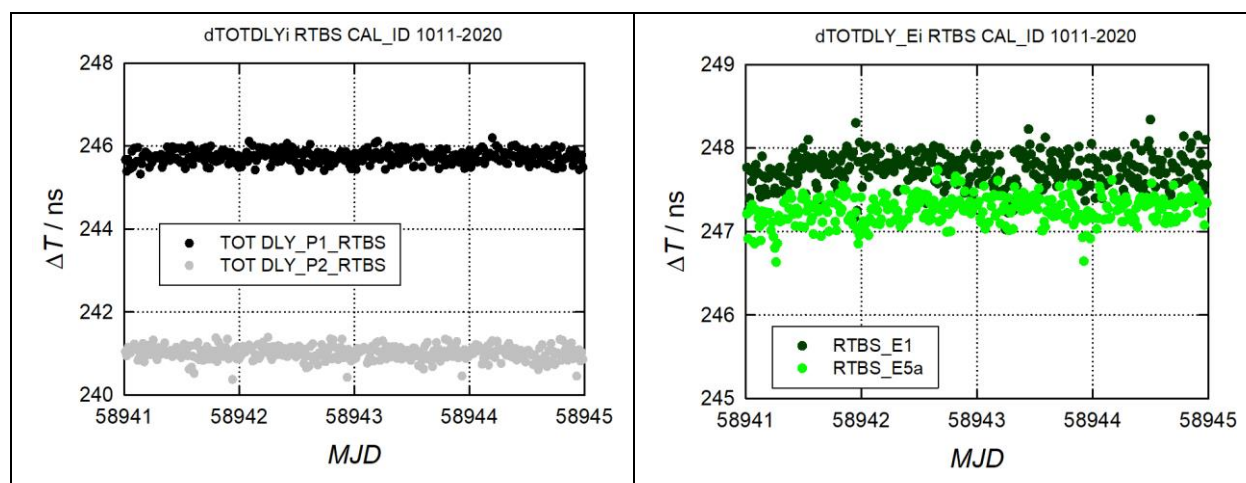

Figure 6-8. TOT DLY in RTBS, reference PTBM; left: GPS $\Delta P1$ (dark) and $\Delta P2$ (light), right: Galileo, $\Delta E1$ (dark green) and $\Delta E5a$ (light green).

6.5. SUMMARY OF RESULTS OBTAINED AT ORB

Table 6-1 $\Delta INT DLY(P_i)$ values and statistical properties (in ns) obtained initially.

$\Delta INT DLY(P_i)$ for receiver at ORB	Mean (ns)	Median (ns)	Std. Dev. (ns)	TDEV (ns)	Number of 16-min epochs
BRUX					
$\Delta P1$	-0.267	-0.267	0.132	0.1	356
$\Delta P2$	-0.431	-0.421	0.146	0.1	356
$\Delta E1$	30.132	30.140	0.120	0.1	356
$\Delta E5a$	29.261	29.263	0.132	0.1	356
ORBA					
$\Delta P1$	-0.077	-0.067	0.168	0.1	356
$\Delta P2$	-0.464	-0.461	0.158	0.1	356
$\Delta E1$	55.940	55.950	0.174	0.1	356
$\Delta E5a$	65.220	65.220	0.144	0.1	356
GRCB					
$\Delta P1$	0.391	0.387	0.12	0.1	356
$\Delta P2$	0.279	0.281	0.155	0.1	356
$\Delta E1$	35.550	35.550	0.125	0.1	356
$\Delta E5a$	33.303	33.307	0.121	0.1	356
RTBS					
$\Delta P1$	245.741	245.75	0.15	0.1	356
$\Delta P2$	241.015	241.035	0.165	0.1	356
$\Delta E1$	247.538	247.75	0.192	0.1	356
$\Delta E5a$	247.260	247.270	0.165	0.1	356

7. OPERATION OF PTBT AT PTB: SECOND PERIOD

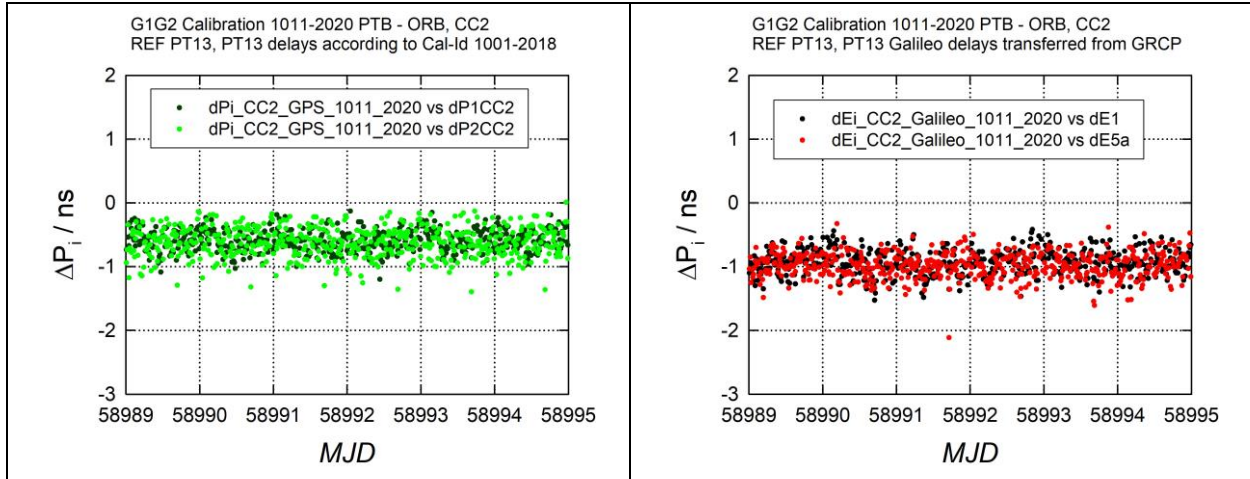

Figure 7-1. ΔP_i values obtained during the second common-clock set-up in PTB.

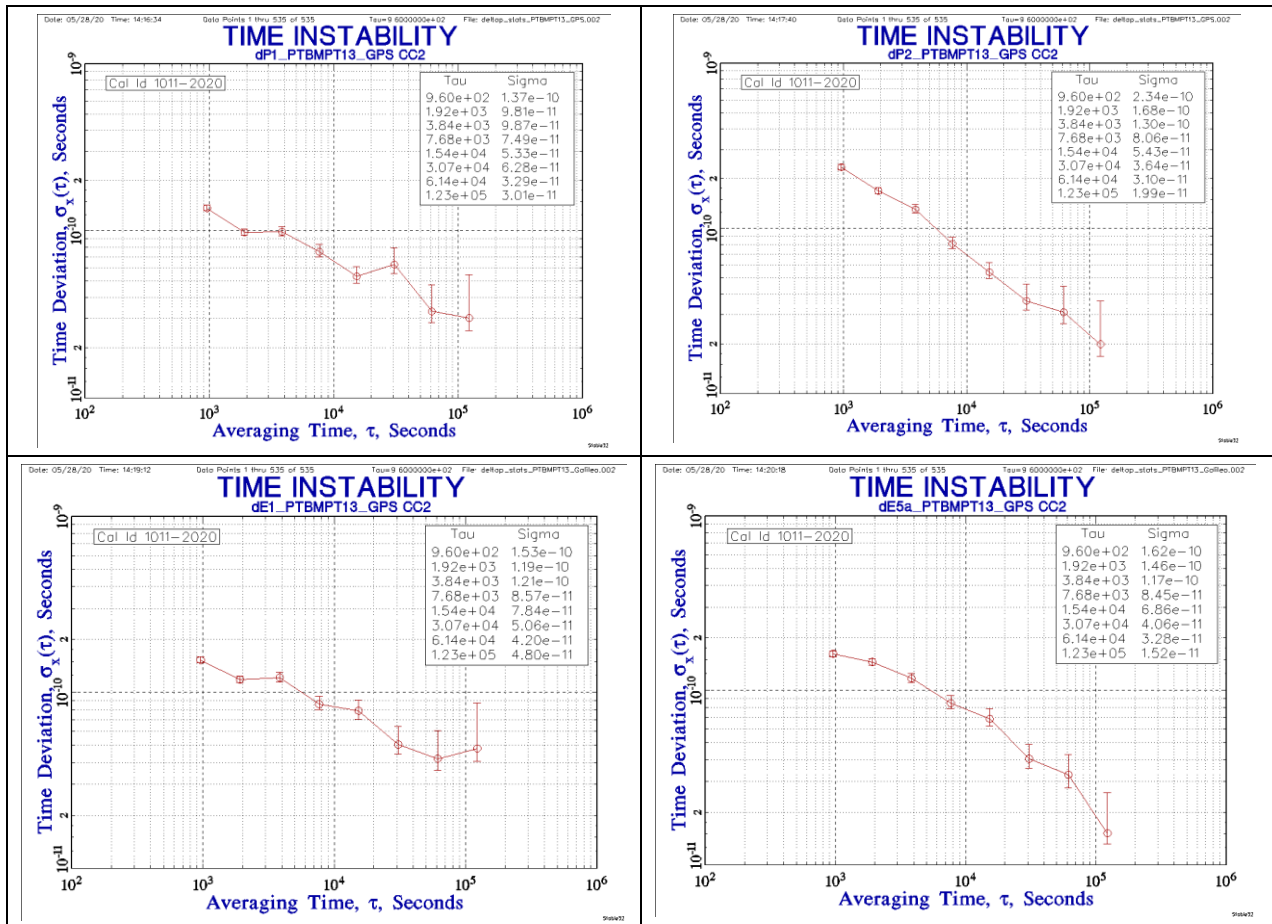

Figure 7-2. TDEV obtained for the four data sets shown in Figure 7-1, GPS (upper row) and Galileo (lower row).

The period 58989 to 58994 (6 days) was chosen to determine PTBT INT DLY values during the common clock period CC2. The results of comparison with PT13 as the reference are shown in

Figure 7-1 illustrating in total 535 ΔP_i and ΔE_i , respectively (see eq. 3) values obtained as mean values over all common view observations at a given epoch. The time instability (TDEV) plots for the data sets follow as Figure 7-2.

7.1. SUMMARY

The numerical results of the two common-clock campaigns at PTB are given in Table 7-1. The largest change noted between CC1 and CC2 amounts 0.56 ns for ΔP_3 . For the evaluation of the delays of the visited receivers the mean values are used. The estimate of the uncertainty contribution is given in Section 8.

Table 7-1: Result of common clock measurements at PTB

Quantity	Median (ns)	Sigma (ns)	TDEV (ns)
ΔP_1 (CC1)	-0.20	0.18	0.1
ΔP_2 (CC1)	-0.34	0.23	0.1
ΔP_3 (CC1)	-0.01		
ΔE_1 (CC1)	-0.54	0.19	0.1
ΔE_{5a} (CC1)	-0.69	0.19	0.1
ΔE_3 (CC1)	-0.38		
ΔP_1 (CC2)	-0.60	0.17	0.1
ΔP_2 (CC2)	-0.62	0.24	0.1
ΔP_3 (CC2)	-0.57		
ΔE_1 (CC2)	-0.95	0.20	0.1
ΔE_{5a} (CC2)	-0.99	0.18	0.1
ΔE_3 (CC2)	-0.90		
Mean values used for evaluation of visited receivers' internal delays			
ΔP_1	-0.40		
ΔP_2	-0.48		
ΔE_1	-0.74		
ΔE_{5a}	-0.84		
Mean values corrected for new PT13 Galileo delays			
ΔE_1	+0.26		
ΔE_{5a}	+0.36		

8. INT DLY UNCERTAINTY EVALUATION

The overall uncertainty of the INT DLY values obtained as a result of the calibration is given by

$$u_{\text{CAL}} = \sqrt{u_a^2 + u_b^2}, \quad (6)$$

with the statistical uncertainty u_a and the systematic uncertainty u_b . The statistical uncertainty is related to the instability of the common clock data collected at ORB and PTB, respectively. The systematic uncertainty is given by

$$u_b = \sqrt{\sum_n u_{b,n}^2}. \quad (7)$$

The contributions to the sum (7) are listed and explained subsequently.

Values in column P3 are calculated according to $u(\text{P3}) = \sqrt{\{u(\text{P1})^2 + (1.54 \times u(\text{P1}-\text{P2}))^2\}}$.
Uncertainties for the Galileo delays are calculated according to $\sqrt{\{u(\text{E1})^2 + (1.26 \times u(\text{E1}-\text{E5a}))^2\}}$.

Note that the uncertainty of the INT DLY values of PTB's fixed receiver PT13 (G) which served as the reference is not included.

Table 8-1: Uncertainty contributions for the calibration of receiver delays

	Uncertainty	Value f1 (ns)	Value f2 (ns)	Value f1-f2 (ns)	Value f3 (ns)	Description
1	u_a (PTB)	0.1	0.1	0.14	0.23	CC measurement uncertainty at PTB, TDEV max. of the two CC campaigns
2	u_a (ORB)	0.1	0.1	0.14	0.23	CC measurement uncertainty, for all four ORB receivers
Result of closure measurement at PTB						
3a	$u_{b,1}$ (GPS)	0.40	0.28		0.56	Misclosure, see Table 7-1
3b	$u_{b,1}$ (Galileo)	0.41	0.30		0.52	Misclosure, see Table 7-1
Systematic components due to antenna installation						
4	$u_{b,11}$	0.1	0.1	0.14	0.28	Position error at PTB
5a	$u_{b,12}$ (ORB)	0.1	0.1	0.14	0.28	Position error at ORB
6	$u_{b,13}$	0.2	0.2	0.0	0.20	Multipath at PTB
7	$u_{b,14}$	0.2	0.2	0.0	0.20	Multipath at ORB
Installation of PTBT and visited receivers						
8	$u_{b,21}$	0.2	0.2	0	0.2	Connection of PTBM to UTC(PTB) (REF DLY)
9	$u_{b,22}$	0.2	0.2	0	0.2	Connection of PTBM to UTC(ORB) (REF DLY)
10	$u_{b,23}$	0.2	0.2	0	0.2	Connection of receivers at ORB to UTC(ORB) (REF DEL)
11	$u_{b,24}$	0.1	0.1	0	0.1	TIC nonlinearities at PTB
12	$u_{b,25}$	0.1	0.1	0	0.1	TIC nonlinearities at ORB
Antenna cable delay						
13	$u_{b,31}$ (PTB)	0.5	0.5	0	0.5	Uncertainty estimate for the PTBM CAB DLY when installed at PTB
14	$u_{b,32}$ (ORB)	0.0	0.0	0	0.0	Uncertainty estimate for the PTBM CAB DLY when installed at ORB
15	$u_{b,33}$ (ORB)	0.5	0.5	0	0.5	Uncertainty estimate for ORB CAB DLY values

As demonstrated in Table 6-1, the four receivers at ORB show almost the same time instability. The TDEV plots (not reproduced in this Report) show marginal differences, and the value of 0.1 ns is a conservative estimate anyway. Thus, a single uncertainty budget can cover all other contributions.

The uncertainty contribution $u_{b,1}$ is based on the difference between the two common clock campaigns in the following way. The respective differences hardly exceed the statistical

measurement uncertainty. So either the difference itself or the statistical measurement uncertainty is considered as measure for the uncertainty, whatever is the larger quantity.

For the generation of the CGGTTS data the PTBT antenna position is manually entered into the processing software in ITRF coordinates before the CCD measurements. These positions could in principle differ from the “true” positions in a different way in each laboratory. This is taken into account by the contributions $u_{b,11}$ and $u_{b,12}$. In the current campaign it was confirmed that the antenna coordinates were determined for all masts involved consistently and the contribution is 0.1 ns at maximum. As a matter of fact, a position error in general could even affect the P1 and P2 delays in a slightly different way, if the distinction between Antenna Reference Point (ARP) and Antenna Phase Centre (APC) is not accurately made. It has been reported that the difference between the two quantities is different for each antenna type but in addition also for the two frequencies received. To be on the safe side, $u_{b,11}$ and $u_{b,12}$ are very conservatively estimated. For other entries, where a frequency dependence can be safely excluded, the entry for P1-P2 is set to zero.

An uncertainty contribution due to potential multipath disturbance is added as $u_{b,13}$ and $u_{b,14}$. If at a given epoch in time the recorded time differences REFSYS would be biased by multipath, this might change with time due to the change in the satellite constellation geometry. [RD05] gives an estimate that has often been referred to. It was agreed at the 2017 meeting of the CCTF WG on GNSS that a 0.2 ns-uncertainty should be attributed to the multipath effect.

The uncertainties of the connection of the receivers to the local time scales ($u_{b,21}$, $u_{b,22}$, $u_{b,23}$) has been estimated as 0.5 ns for PTBM at both locations and as 0.2 ns for the internal set-up at ORB.

The uncertainty contributions $u_{b,24}$ and $u_{b,25}$ are related to imperfections in the TIC in conjunction with the relationship between the zero-crossings of the external reference frequency and the 1 PPS signals. This “nonlinearity” is probably caused by the internal interpolation process. By connecting the travelling TIC successively 10 MHz using cables of different lengths, the effect was estimated to be at most 0.1 ns if 1 PPS signals with a slew rate of approximately 0.5 V/ns are used.

The measurement of antenna cable delays causes contributions $u_{b,31}$, $u_{b,32}$ and $u_{b,33}$. During the current campaign the same (new) PTBM cable was employed in CC1, CC2 and at ORB. CAB DLY values were measured at PTB in previous campaigns, with the cable rolled out and also with the cable on the spool. Each measurement was made with a differential method so that the TIC-internal error should be small anyway. All results agreed within 0.1 ns as long as the same PPS signal source was used, but differed by up to 0.5 ns when the slew rate of the pulse was significantly different. Thus we retain a uncertainty contribution $u_{b,31}$ of 0.5 ns. For the stationary antenna cables at ORB we conservatively assume the same uncertainty of the delay value.

Note anyway that this uncertainty contribution $u_{b,33}$ a priori has no impact on the uncertainty of the time transfer link between PTB and the visited institutes. If the stated CAB DLY for the visited fixed receiver(s) would be erroneous, this would be absorbed in the INT DLY values produced as a result of the campaign.

9. FINAL RESULTS

The results of the calibration campaign G1G2_1011_2020 are summarized in Table 9-1 and Table 9-2. It contains the designation of the visited receiver, the INT DLY values hitherto used, the offsets $\Delta P_i(V,T)$ and $\Delta P_i(T,G)$ (see Section 5, (5)), the new INT DLY values to be used with consent by BIPM, and the uncertainty with which the new values were determined. For calculation, the respective entries from Table 8-1, individually for P1, P2, and combined for L3P (E1, E5a and L3E), were used. Intermediate delays and uncertainties are reported here with two decimal points. According to [RD07], in CGGTTS V2E file headers all delays should be reported with one decimal only, so the final results to be reported are rounded to one decimal.

Table 9-1. Results of the Calibration Campaign G1G2_1011_2020: GPS delays, all values in ns

Receiver	INT DLY(P1), old	INT DLY(P2); old	$\Delta P_1(V,T)$	$\Delta P_2(V,T)$	$\Delta P_1(T,G)$	$\Delta(P_2)(T,G)$	INT DLY(P1), new	$u_{cal, P1}$	INT DLY(P2), new	$u_{cal, P2}$	$u_{cal, L3P}$
BRUX	28.71	24.69	-0.27	-0.42	-0.40	-0.48	28.04	0.96	23.79	0.91	1.14
ORBA	55.60	56.08	-0.07	-0.46	-0.40	-0.48	55.13	0.96	55.14	0.91	1.14
GRCB	33.02	28.01	0.39	0.28	-0.40	-0.48	33.01	0.96	27.81	0.91	1.14
RTBS	0	0	245.75	241.04	-0.40	-0.48	245.35	0.96	240.56	0.91	1.14

Table 9-2. Results of the Calibration Campaign G1G2_1011_2020: Galileo delays, all values in ns

Receiver	INT DLY(E1), old	INT DLY(E5a); old	$\Delta E1$ (V,T)	$\Delta E5a$ (V,T)	$\Delta E1$ (T,G)	$\Delta(E5a)$ (T,G)	INT DLY(1), new	$u_{cal, E1}$	INT DLY(E5a), new	$u_{cal, E5a}$	$u_{cal, L3E}$
BRUX Update V1.2	0	0	30.14	29.26	-0.74 +0.26	-0.84 +0.36	29.40 30.40	0.96	28.42 29.62	0.92	1.12
ORBA Update V1.2	0	0	55.95	65.22	-0.74 +0.26	-0.84 +0.36	55.21 56.21	0.96	64.38 65.58	0.92	1.12
GRCB Update V1.2	0	0	35.55	33.30	-0.74 +0.26	-0.84 +0.36	34.81 35.81	0.96	32.46 33.66	0.92	1.12
RTBS Update V1.2	0	0	247.75	247.27	-0.74 +0.26	-0.84 +0.36	247.01 248.01	0.96	246.43 247.63	0.92	1.12

ANNEX: BIPM CALIBRATION INFORMATION SHEETS

First common clock measurement at PTB

Laboratory:	PTB		
Date and hour of the beginning of	2020-01-28 0:00 UTC (MJD 58876)		
Date and hour of the end of	2020-02-03 24:00 UTC (MJD 58882)		
Information on the system			
	Local:	Travelling:	
4-character BIPM code	PT13	PTBM	
Receiver maker and type:	PolaRx5TR (5.2.0)	PolaRx5TR (5.3.0)	
Receiver serial number:	S/N 470 1292	S/N 3048338	
1 PPS trigger level /V:	1	1	
Antenna cable maker and type: Phase stabilised cable (Y/N):	ECOFLEX15	LMR-400 (N)	
Length outside the building /m:	approx. 25	25	
Antenna maker and type: Antenna serial number:	LEICA AR25 726333, Calib Geo++ 18.08.2015	Navexperience 3G+C REFERENCE S/N RE 0560	
Temperature (if stabilised) /°C			
Measured delays /ns			
	Local:	Travelling:	
Delay from local UTC to receiver 1 PPS-in (X_p) / ns	9.33 ± 0.1 (#)	43.2 +/- 0.2	
Delay from 1 PPS-in to internal Reference (if different): (X_o) / ns	45.0 ± 0.1 (#)	Determined automatically by receiver software	
Antenna cable delay: (X_c) / ns	205.7 ± 0.1	264.9 ± 0.5	
Splitter delay (if any):	N/A		
Data used for the generation of CGGTTS files			
	LOCAL:	Travelling	
<input type="checkbox"/> INT DLY (or X_R+X_S) (GPS) /ns:	29.7 (P1), 27.2 (P2), 31.7 (C1) (*) 31.0 (E1), 30.5 (E5a) (**) 32.0 (E1), 31.7 (E5a) (##)	18.9 (P1) 17.1 (P2) (****) 21.2 (C1) 20.8 (E1), 17.9 (E5a) (****)	
<input type="checkbox"/> INT DLY (or X_R+X_S) (GLONASS) /ns:			
<input type="checkbox"/> CAB DLY (or X_c) /ns:	205.7	264.9	
<input type="checkbox"/> REF DLY (or X_p+X_o) /ns:	54.3	43.2+unknown	
<input type="checkbox"/> Coordinates reference frame:	ITRF (***)	ITRF (****)	
X /m:	+3844059.86 (***)	Mast P10	+3844062.56 (****)
Y /m:	+709661.56 (***)		+709659.49 (****)
Z /m	+5023129.87 (***)		+5023127.88 (****)
			Mast P7
General information			
<input type="checkbox"/> Rise time of the local UTC pulse:	3 ns		

<input type="checkbox"/> Is the laboratory air conditioned:	Yes
Set temperature value and	23.0 °C, peak-to-peak variations 0.5° C

Notes valid for CC1 and CC2:

(#) values determined at installation of PT13 in March 2019, local measurements not repeated

(*) values based on G1 calib 1001-2018, transferred from receiver PT09

(**) Local measurement, transferred from receiver GRCP

(***) values provided by BIPM via Mail 2019-08-07

(****) PTBT INT DLY were adjusted so that PTBM – PT13 for GPS and Galileo were close to zero for convenience.

values used in Version 1.2 of the report

Coordinates of mast P7 (APC) were determined on 12.03.2018 using NRCAN PPP.

Coordinates of mast P9 (APC) were determined on 26.05.2020 using NRCAN PPP

Names of files to be used in processing for site PTB

Travelling receiver GZPTBTMJ.DDD, EZPTBMMJ.DDD

Reference receiver GZPT13MJ.DDD, EZPT13MJ.DDD

PTBM operation at ORB: Receiver BRUX

Laboratory:	ORB
Date and hour of the beginning of measurements:	2020-04-02 00:00 GPS, MJD 58941, 2020
Date and hour of the end of measurements:	2020-04-05 23:59 GPS, MJD 58944, 2020

Information on the system

	Local:	Travelling:
4-character BIPM code	OR5Z	PTBM
• Receiver maker and type:	Septentrio PolaRx5TR (5.3.2)	Septentrio PolaRx5TR (5.3.0)
Receiver serial number:	S/N 3057609	3048338
1 PPS trigger level /V:	1.0 V	1.0 V
• Antenna cable maker and type:	armored cable, N-connectors	PTB-supplied cable, N-connectors
Phase stabilised cable (Y/N):	N	N
Length outside the building /m:	ca 12 m	ca 16 m
• Antenna maker and type:	JAVRINGANT_DM	Navexperience 3G+C
Antenna serial number:	00464	S/N RE 0560
Temperature (if stabilised) /°C	0.1°C	0.1 °C

Measured delays /ns

(if needed fill box "Additional Information" below)

	Local:	Travelling:
• Delay from local UTC to receiver 1 PPS-in:	$X_P + X_O = 68.53$ ns	28.57 ns (delay from UTC(ORB) to the box)
Delay from 1 PPS-in to internal Reference (if different): (see section 2 for details)	Auto-compensation OFF	Determined automatically by receiver software
• Antenna cable delay:	237.50 ns	264.9 ns
Splitter delay (if any):	N/A	N/A
Additional cable delay (if any):	N/A	N/A

Data used for the generation of CGGTTS files OR5Z

Reference : 1018-2017

• INT DLY (GPS) /ns:	28.71 ns (P1) / 24.69 (P2)
• INT DLY (GLONASS) /ns:	
• CAB DLY /ns:	237.50
• REF DLY /ns:	68.53
• Coordinates reference frame:	ITRF

Latitude or X /m:	4027881.69
Longitude or Y /m:	306998.74
Height or Z /m:	4919499.37
Data used for the generation of CGGTTS files PTBM	
RINEX files collected, r2cgggts V8.1 for generation of cgggts files	
Coordinates determined during operation before 2019-12-24	
• INT DLY (GPS) /ns:	18.9 (P1) 17.1 (P2) 21.2 (C1)
• INT DLY (Galileo) /ns:	20.8 (E1), 17.9 (E5a)
• CAB DLY /ns:	264.9 ns
• REF DLY /ns:	28.57 ns
• Coordinates reference frame:	ITRF
Latitude or X /m:	4027863.60
Longitude or Y /m:	307007.56
Height or Z /m:	4919505.98
• Rise time of the local UTC pulse:	
• Is the laboratory air conditioned:	yes
Set temperature value and uncertainty:	+20.3 C to +20.4 C variation during four days
Set humidity value and uncertainty:	RH 21% to 94% variation during four days

PTBM operation at ORB: Receiver ORBA

Laboratory:	ORB	
Date and hour of the beginning of measurements:	2020-04-02 00:00 GPS, MJD 58941, 2020	
Date and hour of the end of measurements:	2020-04-05 23:59 GPS, MJD 58944, 2020	
Information on the system		
	Local:	Travelling:
4-character BIPM code	OR4Z	PTBM
• Receiver maker and type:	Septentrio PolaRx4TR (2.9.6)	Septentrio PolaRx5TR (5.3.0)
Receiver serial number:	S/N 3007657	3048338
1 PPS trigger level /V:	1.0 V	1.0 V
• Antenna cable maker and type:	armored cable, N-connectors	PTB-supplied cable, N-connectors
Phase stabilised cable (Y/N):	N	N
Length outside the building /m:	ca 15 m	ca 16 m
• Antenna maker and type:	SEPCHOKE_MC	Navexperience 3G+C
Antenna serial number:	5467	S/N RE 0560
Temperature (if stabilised) /°C	0.1°C	0.1 °C
Measured delays /ns (if needed fill box "Additional Information" below)		
	Local:	Travelling:
• Delay from local UTC to receiver 1 PPS-in:	$X_P + X_O = 158.40$ ns	28.57 ns (delay from UTC(ORB) to the box)
Delay from 1 PPS-in to internal Reference (if different): (see section 2 for details)	Auto-compensation OFF	Determined automatically by receiver software
• Antenna cable delay:	149.20 ns	264.9 ns
Splitter delay (if any):	N/A	N/A
Additional cable delay (if any):	N/A	N/A
Data used for the generation of CGGTTS files OR4Z Reference : cal_ID 1018-2017		
• INT DLY (GPS) /ns	55.6 ns (P1), 56.08 ns (P2)	
• INT DLY (GLONASS) /ns:		
• CAB DLY /ns:	149.20	
• REF DLY /ns:	158.40	

• Coordinates reference frame:	ITRF
Latitude or X /m:	4027865.54
Longitude or Y /m:	307007.66
Height or Z /m:	4919504.34
Data used for the generation of CGGTTS files PTBM	
RINEX files collected, r2cgggts V8.1 for generation of cggts files	
Coordinates determined during operation before 2019-12-24	
• INT DLY (GPS) /ns:	18.9 (P1) 17.1 (P2) 21.2 (C1)
• INT DLY (Galileo) /ns:	20.8 (E1), 17.9 (E5a)
• CAB DLY /ns:	264.9 ns
• REF DLY /ns:	28.57 ns
• Coordinates reference frame:	ITRF
Latitude or X /m:	4027863.6
Longitude or Y /m:	307007.56
Height or Z /m:	4919505.98
• Rise time of the local UTC pulse:	
• Is the laboratory air conditioned:	yes
Set temperature value and uncertainty:	+20.3 C to +20.4 C variation during four days
Set humidity value and uncertainty:	RH 21% to 94% variation during four days

PTBM operation at ORB: Receiver GRCB

Laboratory:	ORB
Date and hour of the beginning of measurements:	2020-04-02 00:00 GPS, MJD 58941, 2020
Date and hour of the end of measurements:	2020-04-05 23:59 GPS, MJD 58944, 2020

Information on the system

	Local:	Travelling:
4-character BIPM code	OR20	PTBM
• Receiver maker and type:	Septentrio PolaRx5TR (5.2.0)	Septentrio PolaRx5TR (5.3.0)
Receiver serial number:	S/N 4701221	3048338
1 PPS trigger level /V:	1.0 V	1.0 V
• Antenna cable maker and type:	armored cable, N-connectors	PTB-supplied cable, N-connectors
Phase stabilised cable (Y/N):	N	N
Length outside the building /m:	ca 15 m	ca 16 m
• Antenna maker and type:	LEIAR20	Navexperience 3G+C
Antenna serial number:	20220022	S/N RE 0560
Temperature (if stabilised) /°C	0.1°C	0.1 °C

Measured delays /ns

(if needed fill box "Additional Information" below)

	Local:	Travelling:
• Delay from local UTC to receiver 1 PPS-in:	$X_P + X_O = 70.19$ ns	28.57 ns (delay from UTC(ORB) to the box)
Delay from 1 PPS-in to internal Reference (if different): (see section 2 for details)	Auto-compensation OFF	Determined automatically by receiver software
• Antenna cable delay:	96.31 ns	264.9 ns
Splitter delay (if any):	N/A	N/A
Additional cable delay (if any):	N/A	N/A

Data used for the generation of CGGTTS files OR20

Based on alignment of OR20 on OR1Z

• INT DLY (GPS) /ns	33.02 ns (P1), 28.01 ns (P2)
• INT DLY (GLONASS) /ns:	
• CAB DLY /ns:	96.31
• REF DLY /ns:	70.19
• Coordinates reference frame:	ITRF

Latitude or X /m:	4027861.66
Longitude or Y /m:	307007.39
Height or Z /m:	4919507.59
Data used for the generation of CGGTTS files PTBM	
RINEX files collected, r2cgggts V8.1 for generation of cggts files	
Coordinates determined during operation before 2019-12-24	
• INT DLY (GPS) /ns:	18.9 (P1) 17.1 (P2) 21.2 (C1)
• INT DLY (Galileo) /ns:	20.8 (E1), 17.9 (E5a)
• CAB DLY /ns:	264.9 ns
• REF DLY /ns:	28.57 ns
• Coordinates reference frame:	ITRF
Latitude or X /m:	4027863.6
Longitude or Y /m:	307007.56
Height or Z /m:	4919505.98
• Rise time of the local UTC pulse:	
• Is the laboratory air conditioned:	yes
Set temperature value and uncertainty:	+20.3 C to +20.4 C variation during four days
Set humidity value and uncertainty:	RH 21% to 94% variation during four days

PTBM operation at ORB: Receiver RTBS

Laboratory:	ORB	
Date and hour of the beginning of measurements:	2020-04-02 00:00 GPS, MJD 58941, 2020	
Date and hour of the end of measurements:	2020-04-05 23:59 GPS, MJD 58944, 2020	
Information on the system		
	Local:	Travelling:
4-character BIPM code	OR21	PTBM
• Receiver maker and type:	Septentrio PolaRx5TR (5.2.0)	Septentrio PolaRx5TR (5.3.0)
Receiver serial number:	S/N 4701179	3048338
1 PPS trigger level /V:	1.0 V	1.0 V
• Antenna cable maker and type:	armored cable, N-connectors	PTB-supplied cable, N-connectors
Phase stabilised cable (Y/N):	N	N
Length outside the building /m:	ca 15 m	ca 16 m
• Antenna maker and type:	JAVRINGANT_DM	Navexperience 3G+C
Antenna serial number:	00573	S/N RE 0560
Temperature (if stabilised) /°C	0.1°C	0.1 °C
Measured delays /ns (if needed fill box "Additional Information" below)		
	Local:	Travelling:
• Delay from local UTC to receiver 1 PPS-in:	$X_P + X_O = 69.95$ ns	28.57 ns (delay from UTC(ORB) to the box)
Delay from 1 PPS-in to internal Reference (if different): (see section 2 for details)	Auto-compensation OFF	Determined automatically by receiver software
• Antenna cable delay:	0 ns	264.9 ns
Splitter delay (if any):	N/A	N/A
Additional cable delay (if any):	N/A	N/A
Data used for the generation of CGGTTS files OR21		
N/A		
• INT DLY (GPS) /ns		
• INT DLY (GLONASS) /ns:		
• CAB DLY /ns:	0	
• REF DLY /ns:	69.95	
• Coordinates reference frame:	ITRF	

Latitude or X /m:	4027862.14
Longitude or Y /m:	307028.57
Height or Z /m:	4919508.58
Data used for the generation of CGGTTS files PTBM	
RINEX files collected, r2cgggts V8.1 for generation of cggts files	
Coordinates determined during operation before 2019-12-24	
• INT DLY (GPS) /ns:	18.9 (P1) 17.1 (P2) 21.2 (C1)
• INT DLY (Galileo) /ns:	20.8 (E1), 17.9 (E5a)
• CAB DLY /ns:	264.9 ns
• REF DLY /ns:	28.57 ns
• Coordinates reference frame:	ITRF
Latitude or X /m:	4027863.6
Longitude or Y /m:	307007.56
Height or Z /m:	4919505.98
• Rise time of the local UTC pulse:	
• Is the laboratory air conditioned:	yes
Set temperature value and uncertainty:	+20.3 C to +20.4 C variation during four days
Set humidity value and uncertainty:	RH 21% to 94% variation during four days

Second common clock measurement at PTB

Laboratory:	PTB			
Date and hour of the beginning of	2020-05-20 0:00 UTC (MJD 58989)			
Date and hour of the end of	2020-05-25 24:00 UTC (MJD 58994)			
Information on the system				
	Local:	Travelling:		
4-character BIPM code	PT13	PTBM		
Receiver maker and type:	PolaRx5TR (5.2.0)	PolaRx5TR (5.3.0)		
Receiver serial number:	S/N 470 1292	S/N 3048338		
1 PPS trigger level /V:	1	1		
Antenna cable maker and type: Phase stabilised cable (Y/N):	ECOFLEX15	LMR-400 (N)		
Length outside the building /m:	approx. 25	25		
Antenna maker and type: Antenna serial number:	LEICA AR25 726333, Calib Geo++ 18.08.2015	Navexperience 3G+C REFERENCE S/N RE 0560		
Temperature (if stabilised) /°C				
Measured delays / ns				
	Local:	Travelling:		
Delay from local UTC to receiver 1 PPS-in (X_P) / ns	9.33 ± 0.1 (#)	50.5 +/- 0.2		
Delay from 1 PPS-in to internal Reference (if different): (X_0) / ns	45.0 ± 0.1 (#)	Determined automatically by receiver software		
Antenna cable delay: (X_C) / ns	205.7 ± 0.1	264.9 ± 0.5		
Splitter delay (if any):	N/A			
Data used for the generation of CGGTTS files				
	LOCAL:	Travelling		
<input type="checkbox"/> INT DLY (or X_R+X_S) (GPS) /ns:	29.7 (P1), 27.2 (P2), 31.7 (C1) (*) 31.0 (E1), 30.5 (E5a) (**) 32.0 (E1), 31.7 (E5a) (##)	18.9 (P1) 17.1 (P2) (****) 21.2 (C1) 20.8 (E1), 17.9 (E5a) (****)		
<input type="checkbox"/> INT DLY (or X_R+X_S) (GLONASS) /ns:				
<input type="checkbox"/> CAB DLY (or X_C) /ns:	205.7	264.9		
<input type="checkbox"/> REF DLY (or X_P+X_0) /ns:	54.3	50.2+unknown		
<input type="checkbox"/> Coordinates reference frame:	ITRF (***)	ITRF (****)		
X /m:	+3844059.86 (***)	Mast P10	+3844062.13 (****)	Mast P9
Y /m:	+709661.56 (***)		+709658.71 (****)	
Z /m	+5023129.87 (***)		+5023128.29 (****)	
General information				
<input type="checkbox"/> Rise time of the local UTC pulse:	3 ns			
<input type="checkbox"/> Is the laboratory air conditioned:	Yes			
Set temperature value and	23.0 °C, peak-to-peak variations 0.6° C			

END of DOCUMENT