

# GNSS CALIBRATION REPORT

## G1G2\_ 1015-2019

Prepared by: Héctor Esteban (ROA)

Approved by: Héctor Esteban (ROA)

Authorized by: BIPM

Project: EURAMET\_ROA\_G1G2

Code: 1015-2019

Version: 1.0

Date: 15/10/2019

## TABLE OF CONTENTS

1. INTRODUCTION .....	4
1.1. SCOPE OF THE DOCUMENT .....	4
1.2. DOCUMENT STRUCTURE .....	4
1.3. DOCUMENTS .....	5
1.4. ACRONYMS AND ABBREVIATIONS .....	5
2. PARTICIPANTS AND SCHEDULE .....	7
3. THE ROA TRAVELING EQUIPMENT .....	9
4. CALIBRATION PROCEDURE.....	10
5. DATA PROCESSING.....	11
6. UNCERTAINTY ESTIMATION.....	13
7. FINAL RESULTS .....	15
8. ANNEX-A.....	16
8.1. CALIBRATION INFORMATION SHEET AT ROA.....	16
8.2. CALIBRATION INFORMATION SHEET AT NPL.....	19
8.3. CALIBRATION INFORMATION SHEET AT ŪFE .....	23
9. ANNEX-B: CCD AND TDEV ANALYSIS AT EACH LAB .....	26

## LIST OF TABLES AND FIGURES

Table 1-1: List of Acronyms and Abbreviations .....	5
Table 2-1: List of participants. ....	7
Table 2-2: Schedule of the campaign and involved receivers. ....	8
Table 5-1: Initial delays (in ns) of receivers at start of calibration. ....	11
Table 5-2: Raw common clock differences, all values in ns. ....	11
Table 5-3: Closure measurements at ROA, all values in ns. ....	12
Table 6-1: Uncertainty contributions for the calibration of receiver delays.....	13
Table 7-1. Results of the Calibration Campaign G1G2_1015-2019, all values in ns.....	15
Figure 9-1: CCD (left column) and TDEV (right column) at ROA .....	26
Figure 9-2: CCD and TDEV at NPL .....	26
Figure 9-3: CCD and TDEV at ŪFE .....	27

## 1. INTRODUCTION

### 1.1. SCOPE OF THE DOCUMENT

In 2014, as a result of a CCTF recommendation for a collaboration between the BIPM and the RMOs for GNSS equipment calibration, some National Metrology Institutes (NMIs) and Designated Institutes (DIs), were selected to be G1 laboratories, to function as regional nodes for the GPS calibrations. The mission of these Labs, once calibrated by BIPM, was to perform new calibration trips between G2 laboratories, under the responsibility of RMOs.

ROA, as EURAMET G1 laboratory, organized this year, a GPS receiver relative calibration campaign, which took place between two European NMIs or DIs: NPL (United Kingdom) and ŮFE (Czech Republic).

In this campaign was carried out a differential calibration with closure, where the travelling system served as a transfer between all systems visited during the trip and the reference receiver RO\_7. This last was calibrated and reported last year (Cal\_Id=1001-2018 [RD01]), being continuously monitored since then.

### 1.2. DOCUMENT STRUCTURE

The current campaign has been carried out in accordance with ROA calibration procedure and following as much as possible the BIPM guidelines for GNSS calibrations [RD02]. The results will be reported using Cal\_Id 1015-2019, and they will provide the visited receivers' internal delays for GPS C1, P1 and P2 code signals on the two carrier frequencies L1 and L2 (INT DLY P1/P2).

Section 1 of this document gives the introduction, the document structure and a document baseline (in terms of applicable and reference documents and used acronyms).

Section 2 reports, the participating laboratories, dates of visits, and GPS receivers involved in this calibration campaign.

Section 3 presents an overview of the travelling equipment specifically prepared for this activity.

Section 4 basically describes the calibration procedure.

Section 5 explains the data processing carried out by our own software and all the necessary tables to get the results.

Section 6 is focused in the uncertainty estimation, in all the terms taken into account for the uncertainty budget.

Section 7 shows the final results, with the new internal delays, as well as all the necessary information to get them.

The report concludes with the Annex-A for each visited receiver, and the Annex-B, which contains all the figures with the common clock differences (CCD), and their respective time instability (TDEV) plots.

## 1.3. DOCUMENTS

REFERENCES	
RD01	BIPM report 1001-2018 V1.0 / 20190315, subject: 2018 Group 1 GPS calibration trip (Phase 3).
RD02	BIPM guidelines for GNSS calibration, V3.2, 15/02/2016.
RD03	G. Petit, Z. Jiang, P. Moussay, J. White, E. Powers, G. Dudle, P. Uhrich, 2001, Progresses in the calibration of geodetic like GPS receivers for accurate time comparisons, Proc. 15th EFTF, pp. 164-166.
RD04	P. Defraigne and G. Petit, 2003, Time transfer to TAI using geodetic receivers, Metrologia Vol. 40, pp. 184-188.
RD05	J. Kouba, P. Heroux, 2002, Precise Point Positioning Using IGS Orbit and Clock Products, GPS Solutions, Vol. 5, No. 2, pp. 12-28.
RD06	MODEL SR620 Universal Time Interval Counter, Stanford Research Systems, Revision 2.7 (2006).

## 1.4. ACRONYMS AND ABBREVIATIONS

**Table 1-1: List of Acronyms and Abbreviations**

Acronym	Definition
BIPM	Bureau International des Poids et Mesures.
CCD	Common Clock Difference.
CCTF	Consultative Committee for Time and Frequency.
CGGTTS	CCTF Generic GNSS Time Transfer Standard.
CCTF	Consultative Committee for Time and Frequency.
DI	Designated Institute.
EURAMET	European Association of National Metrology Institutes.
GLONASS	GLObal NAVigation Satellite System.
GNSS	Global Navigation Satellite.
GPS	Global Positioning System.
IGS	International GNSS Service.
ITRF	International Terrestrial Reference Frame.
MJD	Modified Julian Date.
NMI	National Metrology Institute.
NPL	National Physical Laboratory, Teddington, UK.
NRCan	Natural Resources Canada.
PPP	Precise Point Positioning.
RINEX	Receiver Independent Exchange Format.
RMO	Regional Metrology Organization.
ROA	Real Instituto y Observatorio de la Armada, San Fernando, Spain.
TDEV	Time Deviation. Is a measure of time stability based on the modified Allan variance.
TIC	Time Interval Counter.

Acronym	Definition
ŮFE	Ústav Fotoniky a Elektroniky Akademie, Prague, Czech Republic.
UTC	Coordinated Universal Time.
UTC(k)	Version of UTC realized at each of the contributing NMIs.
CGGTTS specific acronyms	
CAB DLY	Field present in the CGGTTS header. It is the group delay inside the antenna cable, including both end connectors.
INT DLY	Field present in the CGGTTS header. It is the code- and frequency-dependent combined electric delay of the GNSS signal inside the antenna and the receiver. See also [RD03].
REF DLY	Field present in the CGGTTS header. It is the time offset between the receiver internal clock (or its conventional realization by an external signal) and the local clock at the station. See also [RD03].
REFGPS	Time difference between the reference clock and GPS time, for each satellite at the mid-point of the 13 min track. Receiver delay, cable delay, tropospheric delay and (for one single code) modelled ionospheric delay corrections have been applied.

## 2. PARTICIPANTS AND SCHEDULE

Participating laboratories, dates and GPS receivers involved in the calibration campaign are summarized in Table 2-1 and Table 2-2. Nevertheless, a complete information related with the receiver set-up and the signal distribution system have been provided by all Labs (see relevant Annex-A).

**Table 2-1: List of participants.**

Institute	Point of contact	Postal address
ROA	Dr Héctor Esteban Tel +34 956 54 54 39 hesteban@roa.es	Plaza de las Tres Marinas s/n 11100, San Fernando Spain
NPL	Dr Peter Whibberley Tel. +44 20 8943 6746 peter.whibberley@npl.co.uk	National Physical Laboratory Hampton Road Teddington Middlesex TW11 0LW, UK
ÚFE	Dr Alexander Kuna Tel: +420 266 773 426 kuna@ufe.cz	Ústav Fotoniky a Elektroniky Akademie věd ČR Chaberská 57 182 51 Prague 8 – Kobylisy Czech Republic

**Table 2-2: Schedule of the campaign and involved receivers.**

Institute	Status of equipment	Dates of measurements	Receiver type	BIPM code
ROA	Traveling		DICOM GTR50	TR01
ROA	Group 1 reference	MJD: 58675-58679 11/07/19-15/07/19	Septentrio PolaRx4TR PRO	RO_7
NPL	Group 2	MJD: 58714-58721 19/08/19-26/08/19	DICOM GTR50	NPL1
NPL	Group 2	MJD: 58714-58721 19/08/19-26/08/19	MESIT GTR51	NPL2
ŪFE	Group 2	MJD: 58739-58748 13/09/19-22/09/19	MESIT GTR55	TP01
ŪFE	Group 2	MJD: 58739-58748 13/09/19-22/09/19	MESIT GTR55	TP02
ROA	Group 1 reference	MJD: 58755-58759 29/09/19-03/10/19	Septentrio PolaRx4TR PRO	RO_7



### 3. THE ROA TRAVELING EQUIPMENT

Traveling equipment consists of one shipping box containing the following items:

- 1 GTR50 receiver SN: 0802017.
- 1 Portable PC Toshiba Tecra M9 laptop SN: X7052920H.
- 1 Novatel antenna GPS-703-GGG SN: NEG15300017.
- 60 m H155 antenna cable.

As it is shown in the equipment list, only one receiver was used as traveling equipment. We used a direct antenna cable to connect the GTR50 and the Novatel antenna.

## 4. CALIBRATION PROCEDURE

The calibration has been performed based in C1, P1 and P2 observations provided in the RINEX observation files, using all the GPS satellites in view, at 30 seconds time intervals. We have also used the satellite ephemeris BRDC files provided by IGS.

The coordinates of the antenna phase centre have been especially computed for the calibration period from RINEX files by using the NRCan PPP software [RD04], so the time transfer error caused by this factor is nearly negligible.

Basically the calibration consists on the following. From the known delays of the reference receiver (RO\_7) and an average of the traveling receiver delays between the start and the end of the campaign, we can obtain INTDLY(C1), INTDLY(P1) and INTDLY(P2) for the receivers in the visited Labs. The calibration has consisted in building differential pseudo-ranges for each code C1, P1 and P2 between pairs of receivers in common-clock set-up.

## 5. DATA PROCESSING

For the calculation process we have used a ROA-authored program, in which the common clock differences (CCD) are obtained from the differential pseudo-ranges for each code C1, P1 and P2, only corrected for the geometric effect of receivers' and satellites' positions. For each location, the coordinates of the antenna have been carefully calculated for the calibration period from RINEX files.

As stated before, from the known delays of the reference receiver RO\_7, we have obtained the internal delays for the receivers at the visited sites. Normally the antenna cable delay (CABDLY) is maintained without any change, and the reference delay (REFDLY) is usually updated. Any variation with respect to the true values, will be assumed by the INTDLY results.

**Table 5-1 summarizes the initial delays of receivers at start of calibration. With the reference and cable delay values, new files have been generated from RINEX files according to first paragraph.**

Table 5-2 shows the raw CCD differences at each visited Lab.

**Table 5-1: Initial delays (in ns) of receivers at start of calibration.**

BIPM Acronym	System	INT DLY C1	INT DLY P1	INT DLY P2	REF DLY	CAB DLY
NPL	NPL1	0.0	0.0	0.0	70.1	251.5
	NPL2	0.0	0.0	0.0	68.6	261.2
ÜFE	TP01	14.6	13.5	17.6	0.0	149.0
	TP02	16.1	15.3	17.6	10.6	154.7

**Table 5-2: Raw common clock differences, all values in ns.**

Pair	RAW $\Delta C1$	TDEV (1 day)	RAW $\Delta P1$	TDEV (1 day)	RAW $\Delta P2$	TDEV (1 day)
TR-NPL1	37.00	0.02	37.79	0.02	29.02	0.02
TR-NPL2	-35.89	0.02	-33.75	0.03	-34.34	0.02
TR-TP01	-21.08	0.05	-19.95	0.06	-23.37	0.01
TR-TP02	-20.23	0.03	-19.29	0.04	-20.57	0.01

Taking a close loop to the closure measurements of Table 5-3, we can observe a normal behavior of TR receiver, where the C1, P1 and P2 variation has remained relatively constant (around 0.3 ns).

**Table 5-3: Closure measurements at ROA, all values in ns.**

Pair	RAW $\Delta C1$	TDEV (1 day)	RAW $\Delta P1$	TDEV (1 day)	RAW $\Delta P2$	TDEV (1 day)
TR-RO_7 (before the trip)	0.02	0.10	0.01	0.10	-0.04	0.07
TR-RO_7 (after the trip)	-0.31	0.03	-0.22	0.02	0.01	0.02
Misclosure	0.33		0.23		-0.05	
Mean	-0.15		-0.11		-0.02	

## 6. UNCERTAINTY ESTIMATION

The overall uncertainty of the INT DLY values obtained as a result of the calibration is given by:

$$u_{CAL} = \sqrt{u_a^2 + u_b^2}, \quad (1)$$

with the statistical uncertainty  $u_a$  and the systematic uncertainty  $u_b$ . The statistical uncertainty is related to the instability of the common clock data collected at each site and collected at ROA when the INT DLY of travelling equipment was determined. The systematic uncertainty is given by:

$$u_b = \sqrt{\sum_n u_{b,n}^2} \quad (2)$$

The contributions to the sum (2) are listed and explained subsequently. In the Table 6-1, we have considered the larger type A uncertainty found at remote sites, which is quite small, so there is no need to develop it in detail for each Lab. Note that the uncertainty of the INT DLY values of ROA's fixed receiver RO\_7, which served as the reference, is not included.

**Table 6-1: Uncertainty contributions for the calibration of receiver delays**

	<b>Uncertainty</b>	<b>Value C1 (ns)</b>	<b>Value P1 (ns)</b>	<b>Value P2 (ns)</b>	<b>Description</b>
1	$u_{a(ROA)}$	0.10	0.10	0.10	CCD uncertainty at ROA, TDEV at $\tau = 1$ day.
2	$u_{a(Lab(k))}$	0.10	0.10	0.10	CCD uncertainty at remote Lab, TDEV at $\tau = 1$ day.
<b>Result of closure measurement at ROA</b>					
3	$u_{b,1}$	0.33	0.23	0.05	TR Misclosure, see Table 5-3.
<b>Systematic components due to antenna installation</b>					
4	$u_{b,11}$	0.05	0.05	0.05	Position error at ROA.
5	$u_{b,12}$	0.05	0.05	0.05	Position error at remote Lab.
6	$u_{b,13}$	0.10	0.10	0.10	Multipath at ROA.
7	$u_{b,14}$	0.10	0.10	0.10	Multipath at remote Lab.
<b>Installation of TR and visited receivers</b>					
8	$u_{b,21}$	0.20	0.20	0.20	Connection of TR to UTC(ROA) (REF DLY).
9	$u_{b,22}$	0.20	0.20	0.20	Connection of TR to UTC(k) (REF DLY).
10	$u_{b,23}$	0.50	0.50	0.50	Connection of reference receiver to UTC(ROA) (REF DLY).
11	$u_{b,24}$	0.50	0.50	0.50	Connection of receivers at site k to UTC(k) (REF DLY).
12	$u_{b,25}$	0.10	0.10	0.10	TIC nonlinearities at ROA.
13	$u_{b,26}$	0.10	0.10	0.10	TIC nonlinearities at remote sites.

For each location, the coordinates of the antenna phase centres are especially computed for the calibration period from RINEX files by using the NRCan PPP software. The geometric correction between pairs of antenna phase centres is therefore well determined, and any bias during this calculation affects in the same way to both antennas, so the time transfer error associated to this factor is quite small.

## 7. FINAL RESULTS

The results of the calibration campaign G1G2\_1015-2019 are summarized in Table 7-1. INTDLY C1 new values have been calculated from (the same for P1 and P2 codes):

$$\text{INTDLY C1 new} = -\Delta\text{C1}(T,V) + \Delta\text{C1}(T,R)$$

**Table 7-1. Results of the Calibration Campaign G1G2\_1015-2019, all values in ns.**

Rec. (V)	$\Delta\text{C1}(T,V)$	$\Delta\text{P1}(T,V)$	$\Delta\text{P2}(T,V)$	$\Delta\text{C1}(T,R)$	$\Delta\text{P1}(T,R)$	$\Delta\text{P2}(T,R)$	REF DLY	CAB DLY	INT DLY C1	$u_{\text{cal}} \text{ C1}$	INT DLY P1	$u_{\text{cal}} \text{ P1}$	INT DLY P2	$u_{\text{cal}} \text{ P2}$
NPL1	37.00	37.79	29.02	-0.15	-0.11	-0.02	70.1	251.5	<b>-37.2</b>	0.9	<b>-37.9</b>	0.8	<b>-29.0</b>	0.8
NPL2	-35.89	-33.75	-34.34	-0.15	-0.11	-0.02	68.6	261.2	<b>35.7</b>	0.9	<b>33.6</b>	0.8	<b>34.3</b>	0.8
TP01	-21.08	-19.95	-23.37	-0.15	-0.11	-0.02	0.0	149.0	<b>20.9</b>	0.9	<b>19.8</b>	0.8	<b>23.4</b>	0.8
TP02	-20.23	-19.29	-20.57	-0.15	-0.11	-0.02	10.6	154.7	<b>20.1</b>	0.9	<b>19.2</b>	0.8	<b>20.6</b>	0.8

T=Travelling receiver    V=Visited receiver    R=Reference receiver (RO\_7)

## 8. ANNEX-A

### 8.1. CALIBRATION INFORMATION SHEET AT ROA

Laboratory:	ROA	
Date and hour of the beginning of measurements:	11.07.2019	
Date and hour of the end of measurements:	15.07.2019	
Information on the system		
	Local:	Travelling:
4-character BIPM code	RO_7	
• Receiver maker and type:	PolaRx4TR PRO	DICOM GTR50 SN: 0802017
Receiver serial number:	3102288	
1 PPS trigger level /V:	1 V	
• Antenna cable maker and type:	LDF1RK-50	
Phase stabilised cable (Y/N):		
Length outside the building /m:	Approximately 18 m	Approximately 16 m
• Antenna maker and type:	LEICA AR25 Choke Ring	Novatel antenna GPS-703-GGG
Antenna serial number:	725233	NEG15300017
Temperature (if stabilised) /°C	N	
Measured delays /ns		
	Local:	Travelling:
• Delay from local UTC to receiver 1 PPS-in:	(305.5 ± 0.3) ns	(287.3 ± 0.3) ns
Delay from 1 PPS-in to internal Reference (if different): <small>(see section 2 for details)</small>	(146.8 ± 0.3)	
• Antenna cable delay:	70.0 ns	(266.0 ns ± 0.5) ns
Antenna cable type:	LDF1RK-50	H155
Splitter delay (if any):	14.9	
Additional cable delay (if any):	5.9	
Data used for the generation of CGGTTS files		
• INT DLY (GPS) /ns:	56.3 ns (GPS C1) 55.0 ns (GPS P1) 53.9 ns (GPS P2)	
• INT DLY (GLONASS) /ns:	N/A	
• CAB DLY /ns:	89.9 ns	
• REF DLY /ns:	452.3 ns	
• Coordinates reference frame:	ITRF	
Latitude or X /m:	5105581.92 m	
Longitude or Y /m:	-555193.47 m	
Height or Z /m:	3769704.64 m	
General information		
• Rise time of the local UTC pulse:	< 2 ns	
• Is the laboratory air conditioned:	Yes	
Set temperature value and uncertainty:	(23 ± 2) °C	
Set humidity value and uncertainty:	< 70 %	



Laboratory:	ROA	
Date and hour of the beginning of measurements:	29.09.2019	
Date and hour of the end of measurements:	03.10.2019	
Information on the system		
	Local:	Travelling:
4-character BIPM code	RO_7	
• Receiver maker and type: Receiver serial number:	PolaRx4TR PRO 3102288	DICOM GTR50 SN: 0802017
1 PPS trigger level /V:	1 V	
• Antenna cable maker and type: Phase stabilised cable (Y/N):	LDF1RK-50	
Length outside the building /m:	Approximately 8 m	Approximately 16 m
• Antenna maker and type: Antenna serial number:	LEICA AR25 Choke Ring 725233	Novatel antenna GPS-703-GGG NEG15300017
Temperature (if stabilised) /°C	N	
Measured delays /ns		
	Local:	Travelling:
• Delay from local UTC to receiver 1 PPS-in:	(305.5 ± 0.3) ns	(287.3 ± 0.3) ns
Delay from 1 PPS-in to internal Reference (if different): <small>(see section 2 for details)</small>	(146.8 ± 0.3)	
• Antenna cable delay: Antenna cable type:	70.0 ns LDF1RK-50	(266.0 ns ± 0.5) ns H155
Splitter delay (if any):	14.9	
Additional cable delay (if any):	5.9	
Data used for the generation of CGGTTS files		
• INT DLY (GPS) /ns:	56.3 ns (GPS C1) 55.0 ns (GPS P1) 53.9 ns (GPS P2)	
• INT DLY (GLONASS) /ns:	N/A	
• CAB DLY /ns:	89.9 ns	
• REF DLY /ns:	452.3 ns	
• Coordinates reference frame:	ITRF	
Latitude or X /m:	5105581.92 m	
Longitude or Y /m:	-555193.47 m	
Height or Z /m:	3769704.64 m	
General information		
• Rise time of the local UTC pulse:	< 2 ns	
• Is the laboratory air conditioned:	Yes	
Set temperature value and uncertainty:	(23 ± 2) °C	
Set humidity value and uncertainty:	< 70 %	

### Diagram of the experiment set-up:

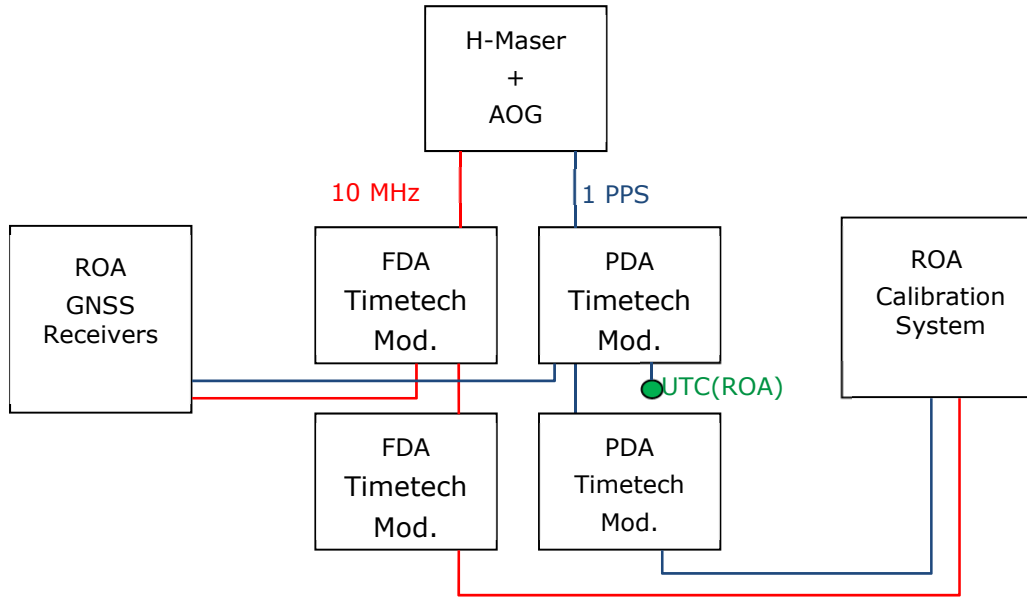

## 8.2. CALIBRATION INFORMATION SHEET AT NPL

Laboratory:	NPL	
Date and hour of the beginning of measurements:	05.05.2017	
Date and hour of the end of measurements:	09.05.2017	
Information on the system		
	Local:	Travelling:
4-character BIPM code	NPL1	
• Receiver maker and type: Receiver serial number:	DICOM GTR50 0807183	DICOM GTR50 0802017
1 PPS trigger level /V:	1.00	
• Antenna cable maker and type: Phase stabilised cable (Y/N):	Andrew Heliax FSJ1-50A cable Y	
Length outside the building /m:	Approximately 6 m	Approximately 7 m (plus approximately 30 m in a roof space with no temperature control)
• Antenna maker and type: Antenna serial number:	(plus approximately 30 m in a roof space with no T. control) Novatel GPS-702	Novatel antenna GPS-703-GGG NEG15300017
Temperature (if stabilized) /°C		
Measured delays /ns		
	Local:	Travelling:
• Delay from local UTC to receiver 1 PPS-in:	70.1 ns ± 0.5 ns	60.7 ns ± 0.5 ns
Delay from 1 PPS-in to internal Reference (if different):		
• Antenna cable delay: Antenna cable type:	251.5 ns ± 0.5 ns	263.8 ns ± 0.3 ns H155
Splitter delay (if any):		
Additional cable delay (if any):		
Data used for the generation of CGGTTS files		
• INT DLY (GPS) /ns:		
• INT DLY (GLONASS) /ns:		
• CAB DLY /ns:		251.5 ns
• REF DLY /ns:		70.1 ns
• Coordinates reference frame:		
Latitude or X /m:		3985120.17
Longitude or Y /m:		-23893.69
Height or Z /m:		4963240.39
General information		
• Rise time of the local UTC pulse:		
• Is the laboratory air conditioned:		Yes
Set temperature value and uncertainty:		(23 ± 1) °C
Set humidity value and uncertainty:		

### Diagram of the experiment set-up:

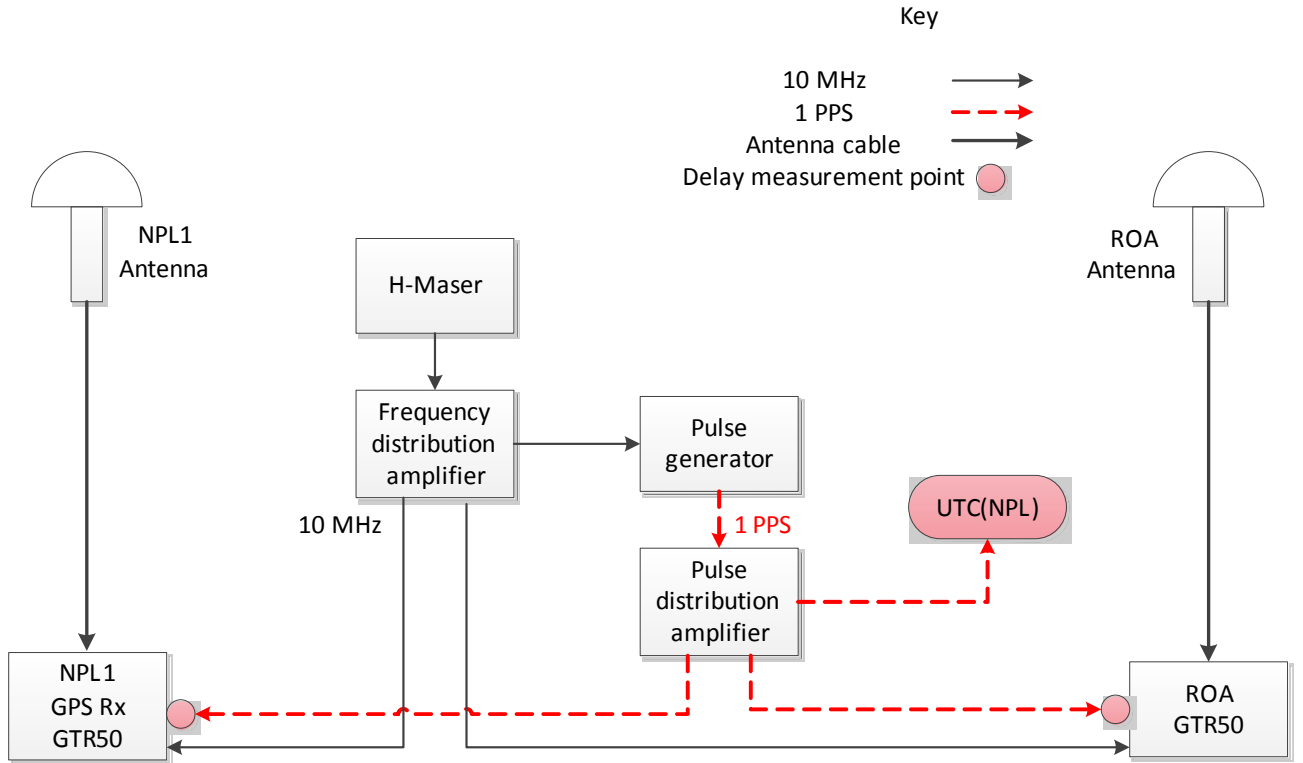

Laboratory:	NPL	
Date and hour of the beginning of measurements:	05.05.2017	
Date and hour of the end of measurements:	09.05.2017	
Information on the system		
	Local:	Travelling:
4-character BIPM code	NPL2	
• Receiver maker and type: Receiver serial number:	MESIT GTR51 1401406	DICOM GTR50 0802017
1 PPS trigger level /V:	1.0	
• Antenna cable maker and type: Phase stabilised cable (Y/N):	Andrew Heliax FSJ1-50A cable Y	
Length outside the building /m:	Approximately 4 m (plus approximately 30 m in a roof space with no temperature control)	Approximately 7 m (plus approximately 30 m in a roof space with no temperature control)
• Antenna maker and type: Antenna serial number:	Novatel NOV703GGG.R2 NEG13440006	Novatel antenna GPS-703-GGG NEG15300017
Temperature (if stabilized) /°C		
Measured delays /ns		
	Local:	Travelling:
• Delay from local UTC to receiver 1 PPS-in:	68.6 ns ± 0.5 ns	60.7 ns ± 0.5 ns
Delay from 1 PPS-in to internal Reference (if different):		
• Antenna cable delay: Antenna cable type:	261.2 ns ± 0.5 ns	263.8 ns ± 0.3 ns H155
Splitter delay (if any):		
Additional cable delay (if any):		
Data used for the generation of CGGTTS files		
• INT DLY (GPS) /ns:		
• INT DLY (GLONASS) /ns:		
• CAB DLY /ns:		261.2 ns
• REF DLY /ns:		68.6 ns
• Coordinates reference frame:		
Latitude or X /m:		3985118.14
Longitude or Y /m:		-23892.71
Height or Z /m:		4963242.02
General information		
• Rise time of the local UTC pulse:		
• Is the laboratory air conditioned:		Yes
Set temperature value and uncertainty:		(23 ± 1) °C
Set humidity value and uncertainty:		

### Diagram of the experiment set-up:

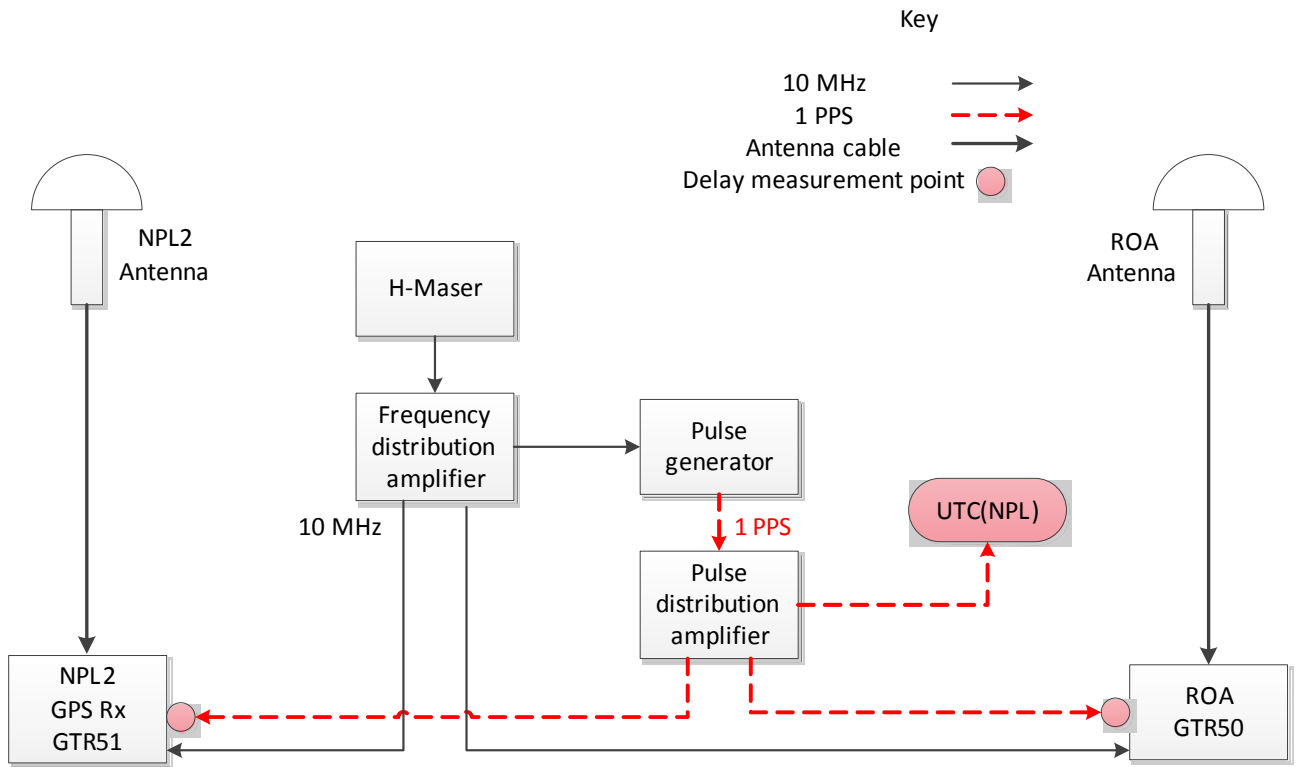

### 8.3. CALIBRATION INFORMATION SHEET AT ŪFE

Laboratory:	ŪFE	
Date and hour of the beginning of measurements:	13.09.2019	
Date and hour of the end of measurements:	22.09.2019	
Information on the system		
	Local:	Travelling:
4-character BIPM code	TP01	
• Receiver maker and type: Receiver serial number:	MESIT asd GTR55 1541941	GTR50 receiver SN: 0802017
1 PPS trigger level /V:	1.0	
• Antenna cable maker and type: Phase stabilised cable (Y/N):	Andrew Heliax FSJ1-50A Y	
Length outside the building /m:	Approximately 35 m	Approximately 45 m
• Antenna maker and type: Antenna serial number:	Novatel GNSS-850 NMLK18480006L	Novatel GPS-703-GGG NEG15300017
Temperature (if stabilized) /°C		
Measured delays /ns		
	Local:	Travelling:
• Delay from local UTC to receiver 1 PPS-in:	0.0 ns ± 0.5 ns	19.2 ns ± 0.5 ns
Delay from 1 PPS-in to internal Reference (if different):		
• Antenna cable delay: Antenna cable type:	149.0 ns ± 0.5 ns	263.8 ns ± 0.3 ns H155
Splitter delay (if any):		
Data used for the generation of CGGTTS files		
• INT DLY (GPS) /ns:	14.60 (C1); 13.50 (P1); 17.60 (P2)	
• CAB DLY /ns:	149.0	
• REF DLY /ns:	0.0	
• Coordinates reference frame:	ITRF2008	
Latitude or X /m:	3967283.154	
Longitude or Y /m:	1022538.181	
Height or Z /m:	4872414.484	
General information		
• Rise time of the local UTC pulse:		
• Is the laboratory air conditioned:	Yes	
Set temperature value and uncertainty:	(23 ± 1) °C	
Set humidity value and uncertainty:		

Laboratory:	ŪFE	
Date and hour of the beginning of measurements:	13.09.2019	
Date and hour of the end of measurements:	22.09.2019	
<b>Information on the system</b>		
	<b>Local:</b>	<b>Travelling:</b>
4-character BIPM code	TP02	
• Receiver maker and type: Receiver serial number:	MESIT asd GTR55	GTR50 receiver SN: 0802017
1 PPS trigger level /V:	1711887	
• Antenna cable maker and type: Phase stabilised cable (Y/N):	1.0 Andrew Heliax FSJ1-50A	
Length outside the building /m:	Y	Approximately 45 m
• Antenna maker and type: Antenna serial number:	Approximately 30 m Novatel GNSS-850	Novatel GPS-703-GGG NEG15300017
Temperature (if stabilized) /°C		
<b>Measured delays /ns</b>		
	<b>Local:</b>	<b>Travelling:</b>
• Delay from local UTC to receiver 1 PPS-in:	10.6 ns ± 0.5 ns	19.2 ns ± 0.5 ns
Delay from 1 PPS-in to internal Reference (if different):		
• Antenna cable delay: Antenna cable type:	137.6 ns ± 0.5 ns	263.8 ns ± 0.3 ns H155
Splitter delay (if any):		
Additional cable delay (if any):		
<b>Data used for the generation of CGGTTS files</b>		
• INT DLY (GPS) /ns:	16,10 (C1); 15,30 (P1); 17,60 (P2)	
• CAB DLY /ns:	137.6	
• REF DLY /ns:	10.6	
• Coordinates reference frame:	ITRF2008	
Latitude or X /m:	3967284.938	
Longitude or Y /m:	1022539.750	
Height or Z /m:	4872412.626	
<b>General information</b>		
• Rise time of the local UTC pulse:		
• Is the laboratory air conditioned:	Yes	
Set temperature value and uncertainty:	(23 ± 1) °C	
Set humidity value and uncertainty:		



**Diagram of the experiment set-up:  
Link to the local UTC of all receivers and Antenna positions**

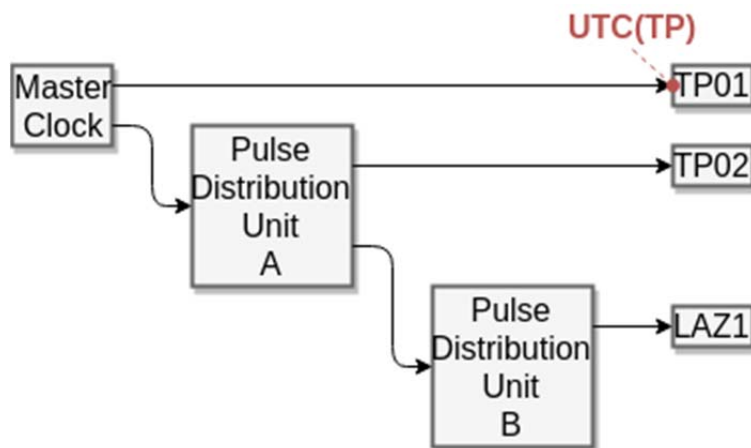

Fig. 1: 1 PPS distribution in UFE.

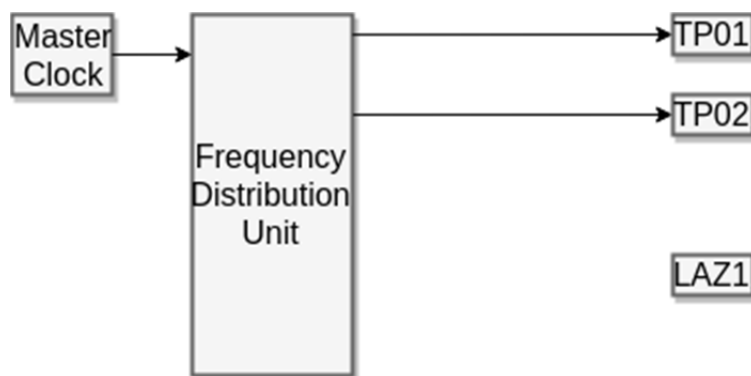

Fig 2. 10 MHz distribution in UFE.

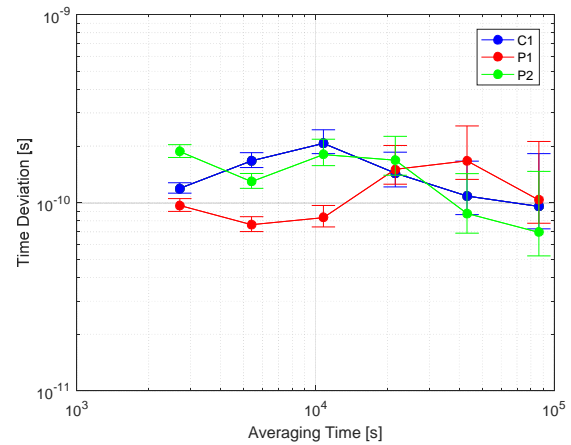
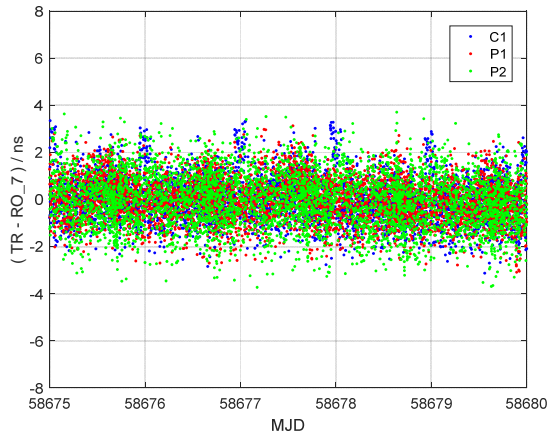

Fig 3: GNSS antennas – TP02 (left ball), TP01 (right ball).

## 9. ANNEX-B: CCD and TDEV analysis at each Lab

**Figure 9-1: CCD (left column) and TDEV (right column) at ROA**

**Before de calibration trip**



**After the calibration trip**

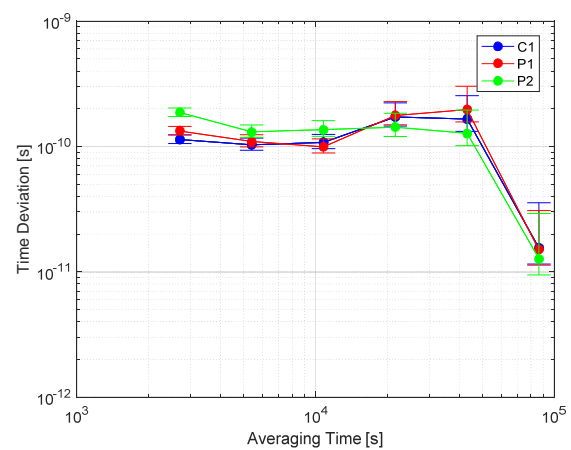
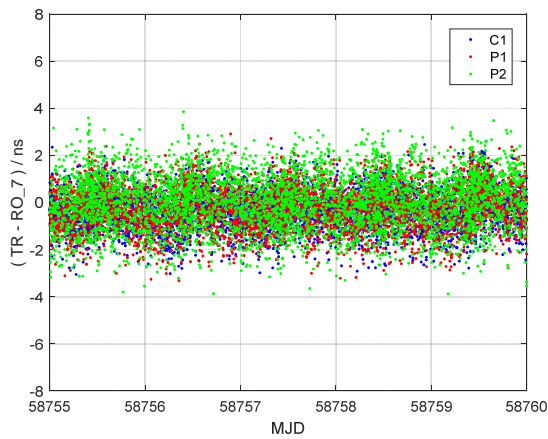

**Figure 9-2: CCD and TDEV at NPL**

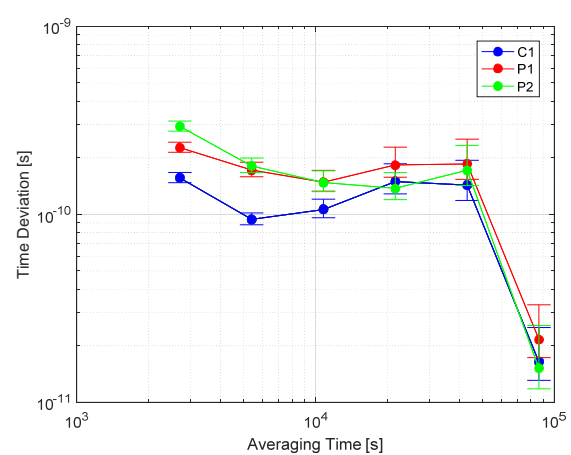
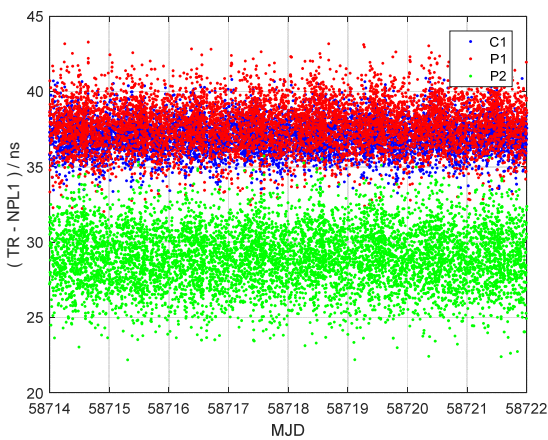

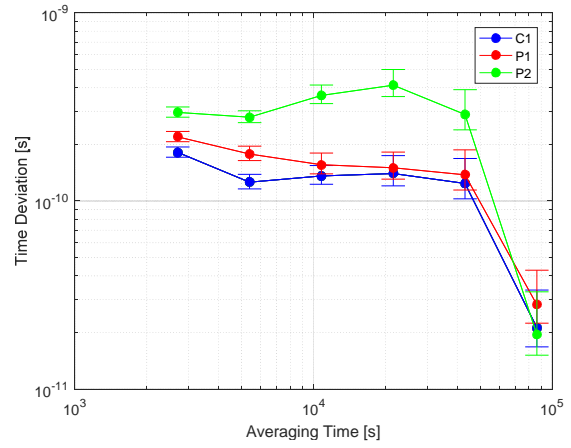
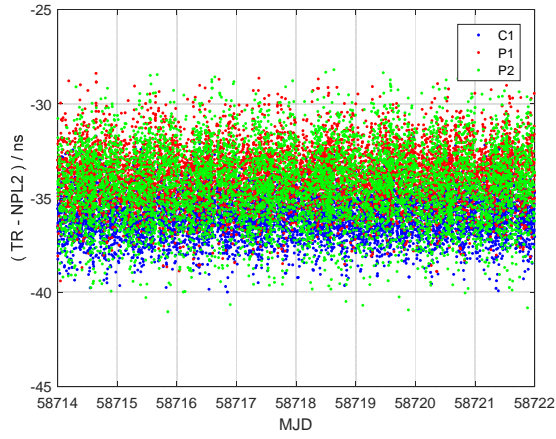
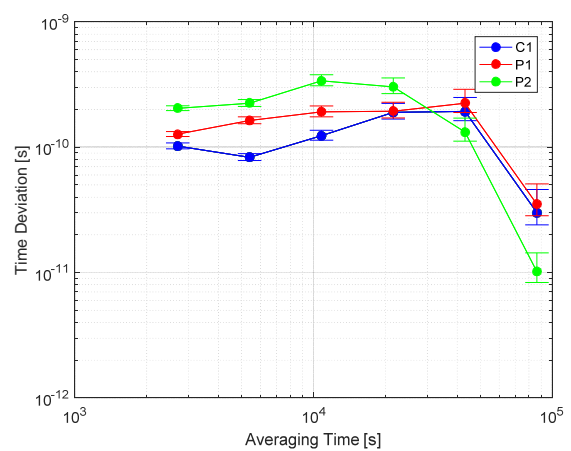
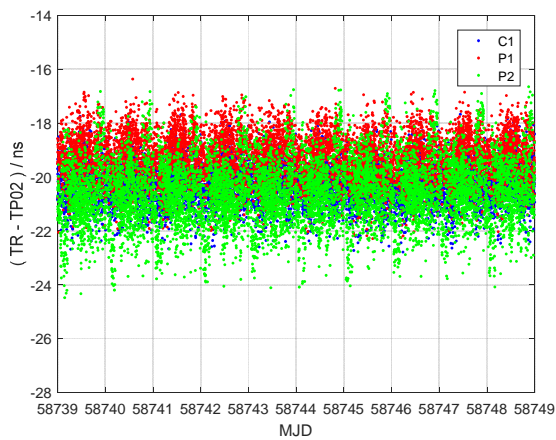
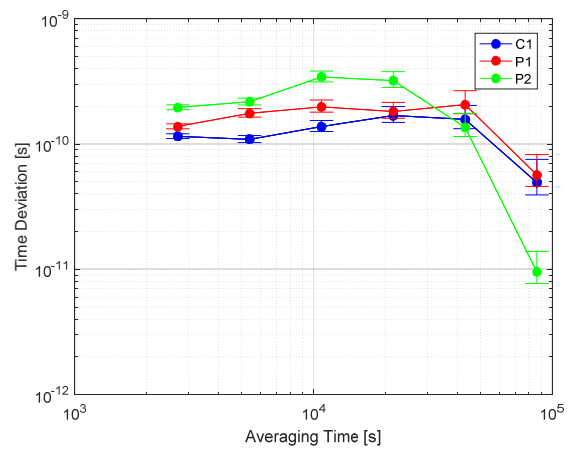
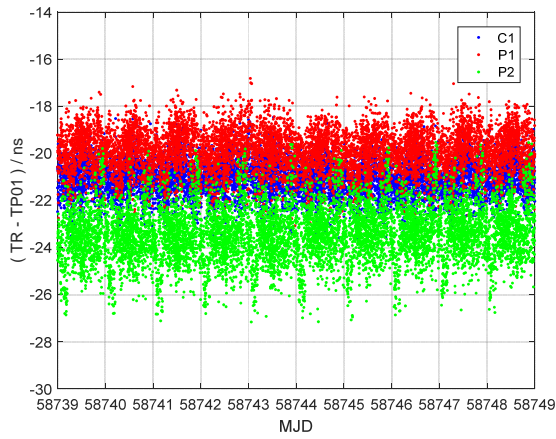

Figure 9-3: CCD and TDEV at ŪFE



## Acknowledgement

We are grateful to the Natural Resources Canada (NRCan) for the use of Precise Point Positioning (PPP) software for positioning computations.

Special thanks to our colleagues of respective laboratories involved in this calibration campaign, in particular to:

Kuna Alexander from ŪFE, and Peter Whibberley and Elizabeth Laier English from NPL, for the unreserved collaboration and support they have provided.

END OF DOCUMENT