

Report for Calibration of G2 Laboratory HKO and SCL by NIM

Kun LIANG¹, Zhiqiang YANG¹, CHEE Shiu Chung², Dawei Xu²,

Hau Wah Lai³

- 1. National Institute of Metrology(NIM), Beijing, China**
- 2. Hong Kong Observatory(HKO), Hongkong, China**
- 3. Standards and Calibration Laboratory(SCL), Hongkong, China**

The report is divided by seven parts. The first part introduces the calibration briefly. And the second and third parts describe separately the equipments and the operation methods, and the experiment setups during the calibration campaign. Part 4 introduce the data processing of the calibration. Then the fifth part describe the the final results by processing. In part 6, it is shown how the calibration uncertainties are evaluated. Climate parameters during the calibration is involved in part 7.

1. Introduction

Time link calibration is the premise of time transfer. Since 2012, BIPM has started to draw up the new guideline for GNSS link calibration and assigned several NMIs including NIM as the group 1 laboratories to implement the possibility of calibration of group 2 laboratories in the local RMO (Regional Metrology Organization) that might give some assist to BIPM.

NIM Cal-001 has been installed and operated at HKO since the end of January of 2018. NIM Cal-001 was sent to SCL from HKO and arrived at SCL in early March of 2018. From mid-February, NIM Cal-001 was sent to NMC A*STAR from SCL and arrived at NMC A*STAR in Mid-April of 2018. Finally, it came back to NIM in early November mainly due to waiting for the authorization of the equipment from NMC A*STAR and their paperwork for the customs.

2. Description of the equipments and the operation method

The NIM transportable calibrator NIM Cal-001 is pictured in figure 1 and depicted schematically in figure 2.

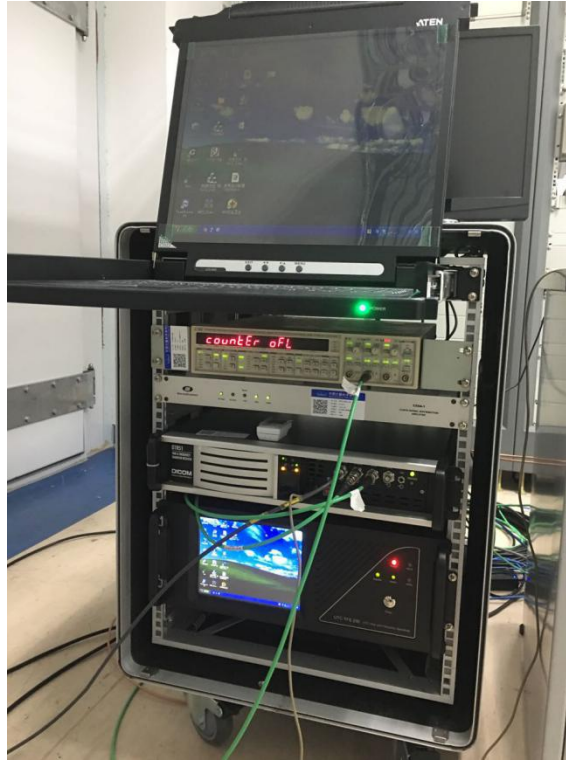

Figure 1. NIM calibrator(NIM Cal-001)

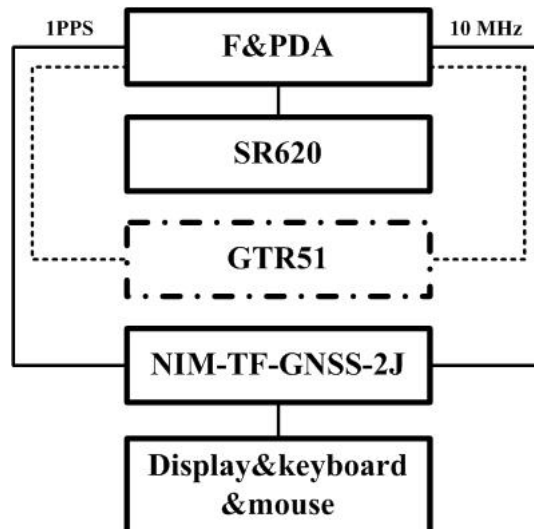

Figure 2. Schematic of NIM Cal-001

Referring to figure 2, the function of each part is as follows.

1. **NIM-TF-GNSS-2J**: GNSS time and frequency transfer travelling receiver
2. **SR620**: Time interval counter used to measure the reference delay
3. **P&FDA**: phase and frequency distribution amplifier
4. **Display&keyboard&mouse (KVM)**: Interface between PC and the user, the interface for control of the receiver and logging of GNSS measurement data
5. **GTR51**: Dicom company product
Physical Size: : 62cm(width)*78cm(height)*89cm(depth) (without the wheels)
wheel height:12cm
rough weight: 101 kg

List of supplied items

Receivers:

IM09: NIM-TF-GNSS-2J(with antenna AT1675 AT-200)

IM11: GTR51(with antenna NOV703GGG)

Others:

KVM(ATEN)

PDA and FDA(SDI)

SR620(SRS)

cables

Connectors

All information about the equipments for the calibrator and the receivers to be calibrated are list in table 1. At SCL, the antenna cables for the calibrator cannot be installed since there is no specific path for the cables to be installed. There are only one spared antenna cable installed inside the wall in advance for calibration use, so only IM09 with this cable was used for the calibration measurements. At NMC A*STAR, there are the similar problems, however, there were two spared cables for the calibration use.

Table 1. Sites used for the calibration

Timing lab	Site name	BIPM code	Model	Role	Notes
NIM	IM06	IM06	Dicom GTR50	Reference receiver	Master
NIM	IM09	IM09	NIM-TF-GNSS-2J	Traveling receiver	Traveling
NIM	IM11	IM11	GTR51	Traveling receiver	Traveling
HKO	HKO1	HKO1	TTS-4	Receiver to be calibrated	
HKO	HKO2	HKO2	TTS-4	Receiver to be calibrated	
SCL	SCL2	SCL2	PolaRx5TR	Receiver to be calibrated	Master, calibrated with IMEC

The whole calibration tour includes start CCD before calibration, calibration on site and closure CCD as shown in table 2.

Table 2. Measurements used for the calibration

Time period	Place	Operation	Notes
MJD 58110-MJD 58119	NIM	Start CCD before calibration	Measurements used for computation from MJD 58110-MJD 58119
MJD 58159-MJD 58168	HKO	Calibration on site	Measurements used for computation from MJD 58159-MJD 58168

MJD 58203-MJD 58210	SCL	Calibration on site	Measurements used for computation from MJD 58203-MJD 58210
MJD 58460 to MJD 58466	NIM	Closure CCD after calibration	Measurements used for computation from MJD 58460-MJD 58466

The data from MJD 58159 to MJD 58168 after the signal transmitting was closed which looks normal are finally used for computation.

The calibration method, the differential calibration with closure of GPS (Global Positioning System) time and frequency transfer receiver, is used. Its principle concept is addressed in [1].

3. Experiment setups

In the campaign, the receivers used were as follows in table 1. IM06 (site name for CGGTTS is IM06) is the master GPS time and frequency transfer receiver of NIM for TAI contribution and the reference receiver. The calibrator at HKO and SCL was installed and the setups and the sub-delay information for start and closure experiments at NIM and calibration experiments on site at HKO and SCL were depicted in figure 4 and 5.

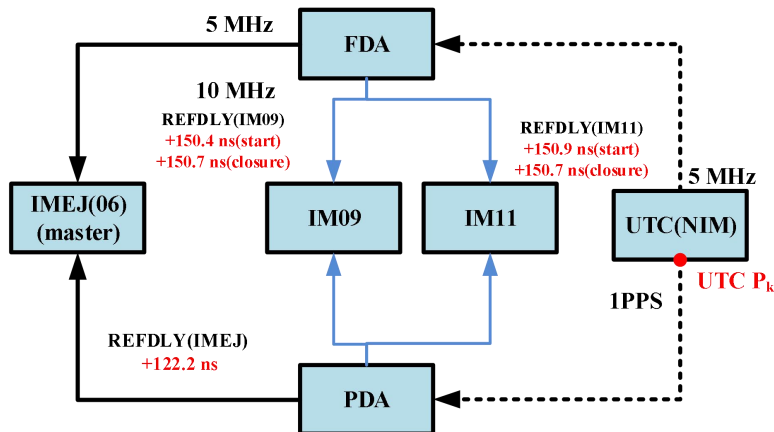

Figure 3. Experiment setup @NIM(for CCD experiments)

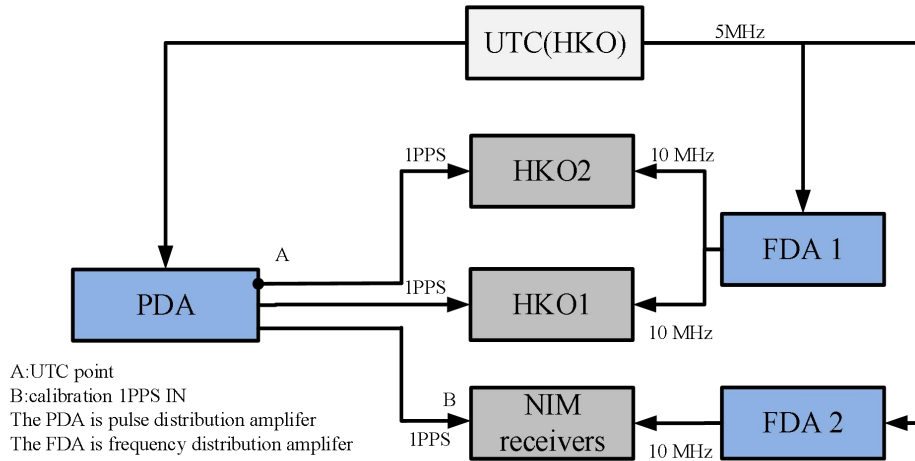

Figure 4. Experiment setup @HKO(for CCD experiments)

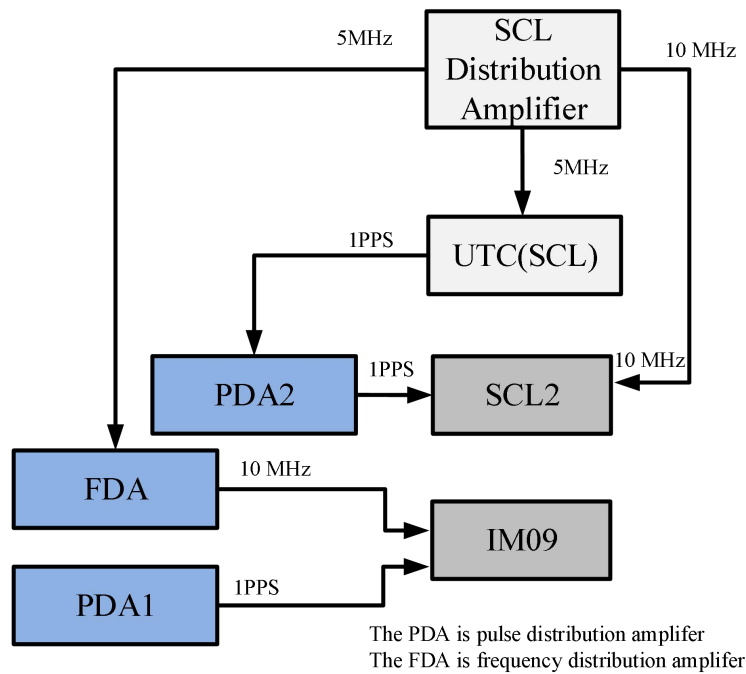

Figure 5. Experiment setup @SCL(for CCD experiments)

4. Data processing

The difference of the total delay for the two receivers, such as A and B, is the antenna cable delay(CABDLY) plus the internal delay(INTDLY), and minus reference delay(REFDLY).

The raw differences between two receivers are given by

$$RAWDIFF(P1/P2)_{A-B} = \Delta CABDLY_{A-B} + \Delta INTDLY(P1/P2)_{A-B} - \Delta REFDLY_{A-B} \quad (1)$$

where $RAWDIF(P1/P2)_{A-B}$ is the raw difference of two receivers. $\Delta CABDLY_{A-B}$ and $\Delta REFDLY_{A-B}$ is given in table 3. P3 results are calculated by the formula $P3=P1*2.54573-P2*1.54573$.

Table 3. REFDLY and CABDLY differences between stations and traveling receivers

Pair	MJD	Δ REFDLY(ns)	Δ CABDLY(ns)
IM09-IM06	58110-58119	28.7	-45.7
IM11-IM06	58110-58119	29.2	-71.6
HKO1-IM09	58159-58168	-39.1	130.9
HKO1-IM11	58159-58168	-39.1	156.8
HKO2-IM09	58159-58168	-27.9	220.3
HKO2-IM11	58159-58168	-27.9	246.2
SCL2-IM09	58203-58210	0	-14.6
IM09-IM06	58460-58466	29.0	-45.7
IM11-IM06	58460-58466	29.0	-71.6

5. Calibration computation and calibration values

Raw P1, P2, P3 and P1-P2 differences calculated between stations and traveling receivers are given in table 4. The values for Δ INTDLY between a given pair of receivers are computed using Eq.(1) and given in table 5. Closure values(the difference between the mean values before calibration and after calibration) are given in table 6. The values of INTDLY for receiver HKO1, HKO2 and SCL2 are computed using Δ INTDLY between receivers to be calibrated and the traveling receivers and Δ INTDLY between the traveling receivers and IM06 (values from 1001-2018). The values of INTDLY are given in table 7.

CGGTTS file headers

IM06

MJD 58110-58119

INT DLY = -31.3 ns (GPS P1), -17.9 ns (GPS P2), -30.4 ns (GPS C1)

CAB DLY = 248.7 ns

REF DLY = 122.2 ns

MJD 58460-58466

INT DLY = -31.3 ns (GPS P1), -17.9 ns (GPS P2), -30.4 ns (GPS C1)

CAB DLY = 248.7 ns

REF DLY = 121.7 ns

MJD 58470-58477

INT DLY = -31.8 ns (GPS P1), -18.4 ns (GPS P2), -31.0 ns(GPS C1)

CAB DLY = 248.7 ns

REF DLY = 121.7 ns

IM09

MJD 58110-58119

INT DLY = 0.0 ns (GPS P3)

CAB DLY = 203.0 ns (GPS)

REF DLY = 150.4 ns

MJD 58159-58168

INT DLY = 0.0 ns (GPS P3)

CAB DLY = 203.0 ns (GPS)

REF DLY = 0.2 ns

MJD 58203-58210

INT DLY = 0.0 ns (GPS P3)

CAB DLY = 526.6 ns

REF DLY = 10.0 ns

MJD 58460-58466

INT DLY = 0.0 ns (GPS P3)

CAB DLY = 203.0 ns

REF DLY = 150.7 ns

IM11

MJD 58110-58119

INT DLY = -29.2 ns (GPS C1), -35.0 ns (GPS P1), 0.0 ns (GPS C2), -37.5 ns (GPS P2), 0.0 ns (GPS L5)

CAB DLY = 177.1 ns

REF DLY = 150.9 ns

MJD 58159-58168

INT DLY = -29.2 ns (GPS C1), -35.0 ns (GPS P1), 0.0 ns (GPS C2), -37.5 ns (GPS P2), 0.0 ns (GPS L5)

CAB DLY = 177.1 ns

REF DLY = 0.2 ns

MJD 58460-58466

INT DLY = -29.2 ns (GPS C1), -35.0 ns (GPS P1), 0.0 ns (GPS C2), -37.5 ns (GPS P2), 0.0 ns (GPS L5)

CAB DLY = 177.1 ns

REF DLY = 150.7 ns

HKO1

MJD 58159-58168

INT DLY = [ns] GPS, L1C:-22.50 L2C:0.00 L1P:0.00 L2P:0.00 L5P:0.00,GLO: L1C:-228.06 L2C:0.00 L1P:0.00 L2P:0.00

CAB DLY = 333.89 ns (GPS)

REF DLY = 12.70 ns (1PPS DLY: 7.92 ns, phase corr: 4.78 ns)

HKO2

MJD 58159-58168

INT DLY = [ns] GPS: L1C:-19.66 L2C:0.00 L1P:0.00 L2P:0.00 L5P:0.00, GLO: L1C:-225.07 L2C:0.00 L1P:0.00 L2P:0.00

CAB DLY = 423.33 ns (GPS), 423.33 ns (GLONASS)

REF DLY = 1.49 ns (1PPS DLY: 7.92 ns, phase corr: -6.43 ns)

SCL2

MJD 58203-58210

INT DLY = 0.0 ns (GPS P1) 0.0 ns (GPS P2) CAL_ID =

CAB DLY = 512.0 ns

REF DLY = 10.0 ns

5.1. Raw differences

Table 4. Raw differences between stations and traveling receivers

Pair	MJD	$\Delta P1(ns)$	$\Delta P2(ns)$	$\Delta P3(ns)$	$\Delta P1-P2(ns)$
IM09-IM06	58110-58119	-19.0	-14.1	-26.7	-5.0
IM11-IM06	58110-58119	-3.4	-1.0	-7.2	-2.4
HKO1-IM09	58159-58168	42.2	35.1	52.1	7.1
HKO1-IM11	58159-58168	33.4	25.3	46.0	8.1
HKO2-IM09	58159-58168	26.6	22.9	33.4	3.8
HKO2-IM11	58159-58168	18.1	13.0	25.8	5.0
SCL2-IM09	58203-58210	70.3	65.0	78.4	5.3
IM09-IM06	58460-58466	-18.3	0.4	-13.2	0.4
IM11-IM06	58460-58466	-3.2	0.5	-0.1	0.8

5.2. $\Delta INTDLY$

Table 5. INTDLY differences between stations and traveling receivers

Pair	$\Delta INTDLY(P1)(ns)$		$\Delta INTDLY(P2)(ns)$		$\Delta INTDLY(P3)(ns)$	
IM09-IM06 _{before}	54.4	31.3	59.8	17.9	47.3	52.0
IM11-IM06 _{before}	96.4	-3.2	99.3	-19.1	93.2	21.4
HKO1-IM09	-127.8	0	-134.9	0	-116.8	0
HKO1-IM11	-162.5	35.0	-170.6	37.5	-145.0	31.1
HKO2-IM09	-221.6	0	-225.3	0	-215.9	0
HKO2-IM11	-256.0	35.0	-261.1	37.5	-248.1	31.1
SCL2-IM09	84.9	0	79.6	0	93.1	0
IM09-IM06 _{after}	56.4	31.3	75.1	17.9	27.5	52.0
IM11-IM06 _{after}	97.4	-3.7	101.1	-19.6	91.7	21.4

Note: The values in second column of $\Delta INTDLY (P1/P2/P3)$ are the compensation values. This compensation is caused by the deviation of the delay values in the file header from the measured values. The values of this column should be compensated to the values in the first column while calculating for calibration.

5.3. Closure values

Table 6. Closure values

Pair	$\Delta P1(ns)$	$\Delta P2(ns)$	$\Delta P3(ns)$
IM09-IM06	-0.7	-0.9	-0.6
IM11-IM06	-0.2	-0.9	-0.6

5.4. Calibration values

Table 7. INTDLY for stations HKO1, HKO2 and SCL2

Rcvr	P1(ns)	P2(ns)	P3(ns)
HKO1	-17.2	-19.0	-14.1
HKO2	-25.9	-28.8	-21.4
SCL2	25.5	25.1	25.9

6. Uncertainty evaluation

As shown in table 8, we evaluated the uncertainty from the sources as follows and got the combined uncertainty values that are better than 1.7 ns conservatively for P1, P2 and P3 codes. All the measurements related to the cable and reference delays were done with SR620 on the trigger level 1.0 V. And the uncertainties from position references and multipaths are just referenced to the description of the guideline. The u_a values are from TDEV of the corresponding CCD results shown in the figures in Annex 6.

Table 8. Uncertainty contributions

Unc.	P1 (ns)	P2 (ns)	P3 (ns)	Description
u_a (T-V)	0.2	0.2	0.3	RAWDIF (traveling-visited)
u_a (T-R)	0.2	0.2	0.3	RAWDIF (traveling-reference)
u_a	0.3	0.3	0.4	
Misclosure				
$u_{b,1}$	0.7	0.9	0.6	observed mis-closure
Systematic components related to RAWDIF				
$u_{b,11}$	0.05	0.05	0.05	Position error at reference
$u_{b,12}$	0.05	0.05	0.05	Position error at visited
$u_{b,13}$	0.3	0.3	0.3	Multipaths at reference
$u_{b,14}$	0.3	0.3	0.3	Multipaths at visited
Link of the Traveling system to the local UTC(k)				
$u_{b,21}$	0.5	0.5	0.5	REFDLYT (at ref lab)
$u_{b,22}$	0.5	0.5	0.5	REFDLYT (at visited lab)
$u_{b,TOT}$	1.2	1.3	1.1	
Link of the Reference system to its local UTC(k)				

ub,31	0.5	0.5	0.5	REFDLY _R (at ref lab)
Link of the Visited system to its local UTC(<i>k</i>)				
ub,32	0.5	0.5	0.5	REFDLY _V (at visited lab)
ub,SYS	1.4	1.5	1.3	Components of equation (2)
u _{CAL}	1.6	1.7	1.5	Composed of u _a and u _{b,SYS}
Antenna cable delays				
ub,41	0.5	0.5	0.5	CABDLY _R
ub,42	0.5	0.5	0.5	CABDLY _V
Combined Uncertainty: 1.7 ns				

7. Climate parameters

7.1. Temperature and humidity

22°C ±1°C

40% ±5%

7.2. Reference signal

Rise time of the local UTC pulse: < 5 ns

References:

[1] BIPM. BIPM guidelines for GNSS calibration(V3.2). 05, 02, 2016.

Annex 1. CCD results for HKO

1. Start CCD before calibration

IM09-IM06

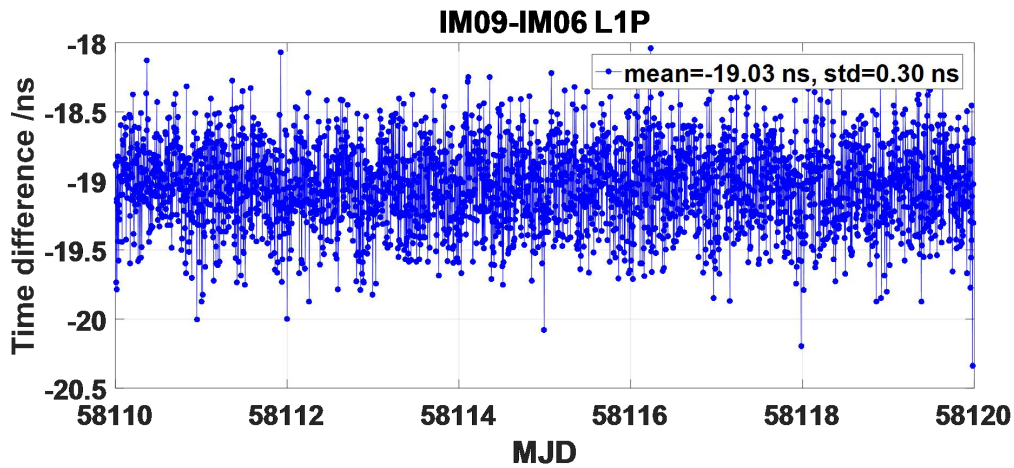

Figure 6. CCD between IM09 and IM06 at NIM(L1P)

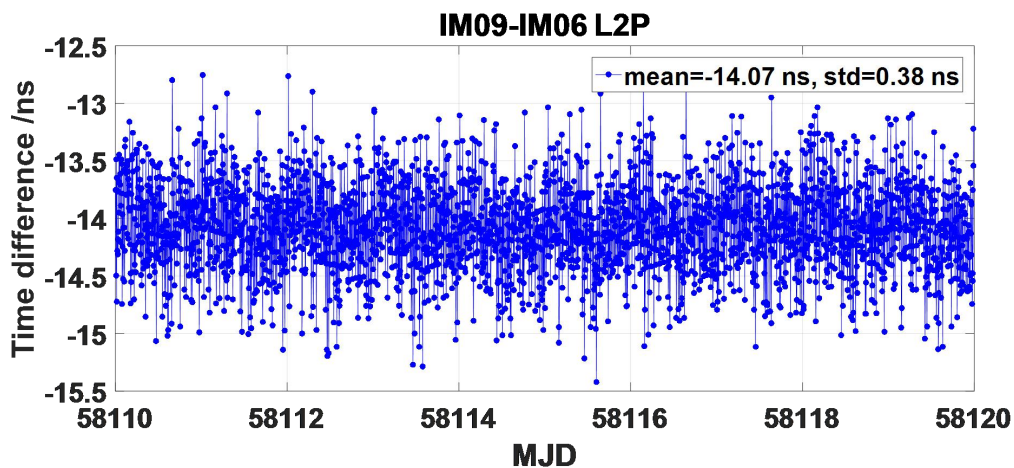

Figure 7. CCD between IM09 and IM06 at NIM(L2P)

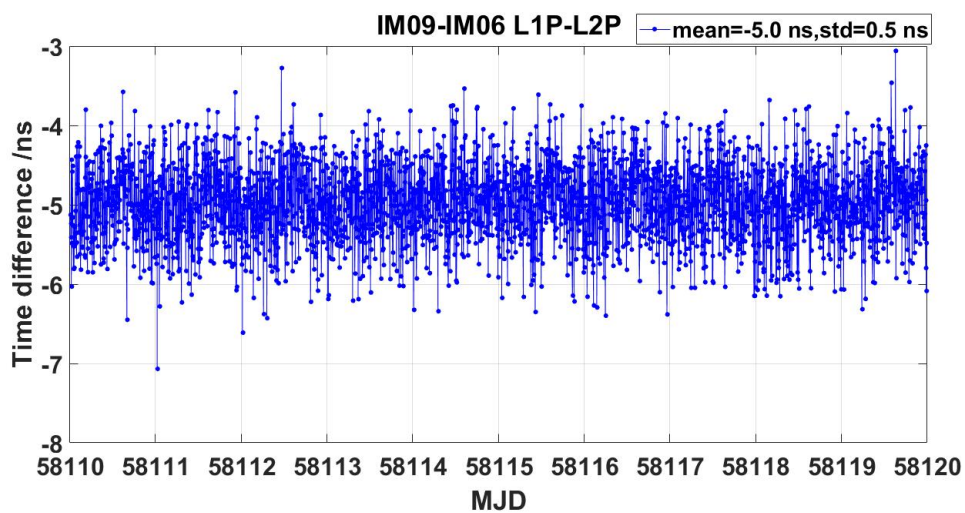

Figure 8. CCD between IM09 and IM06 at NIM(L1P-L2P)

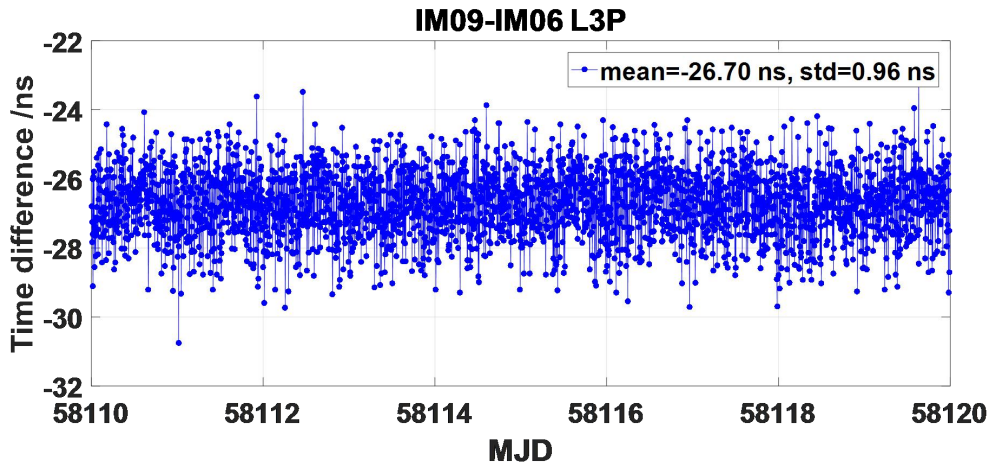

Figure 9. CCD between IM09 and IM06 at NIM(L3P)

IM11-IM06

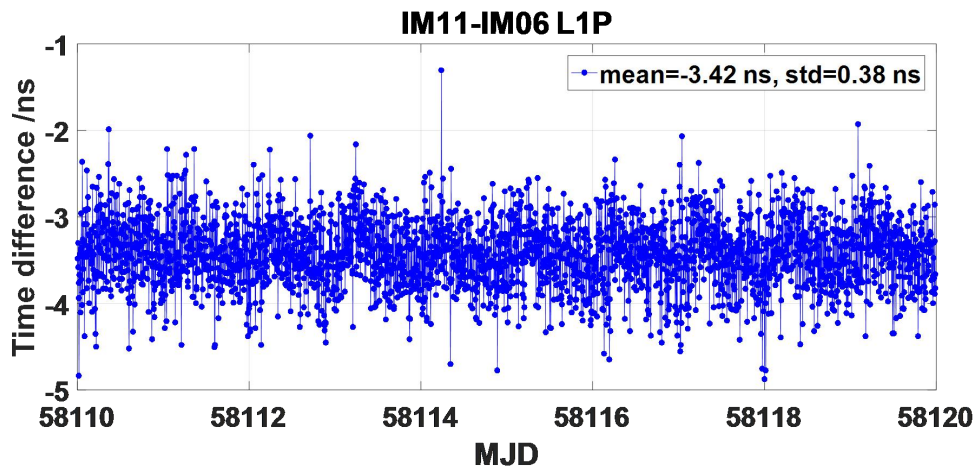

Figure 10. CCD between IM11 and IM06 at NIM(L1P)

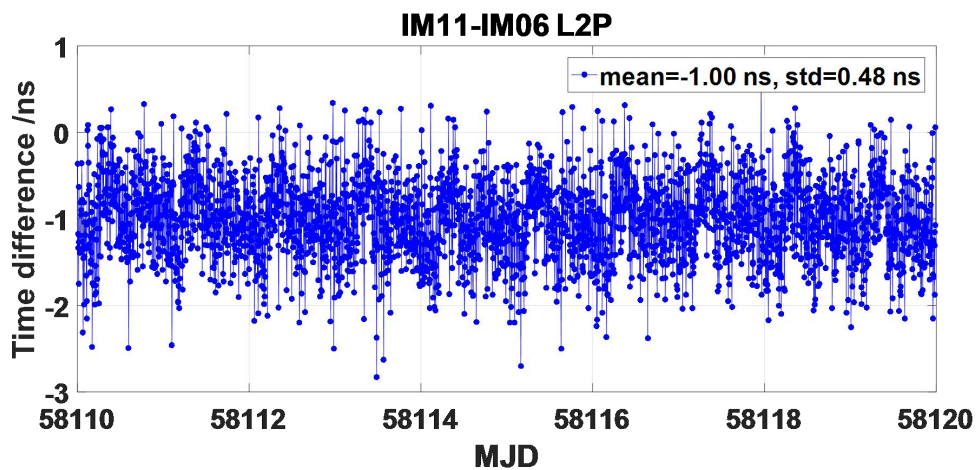

Figure 11. CCD between IM11 and IM06 at NIM(L2P)

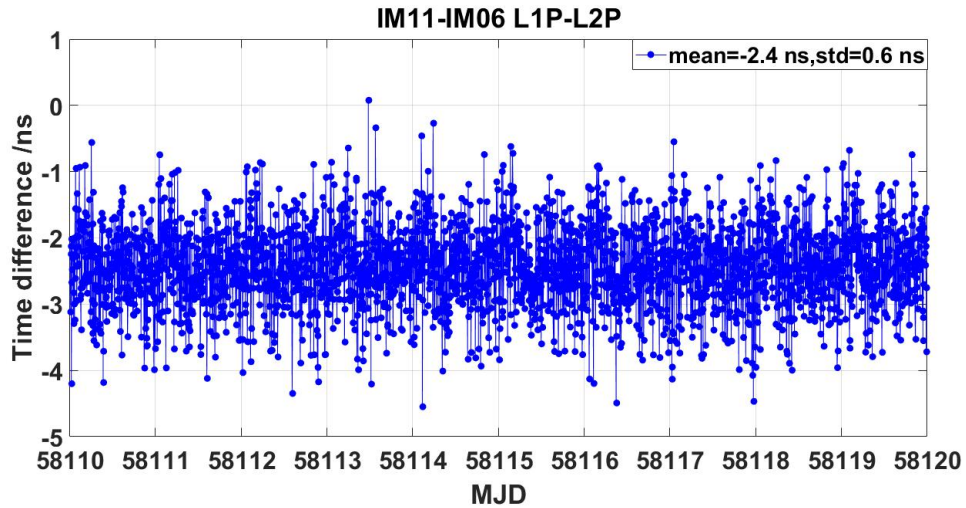

Figure 12. CCD between IM11 and IM06 at NIM(L1P-L2P)

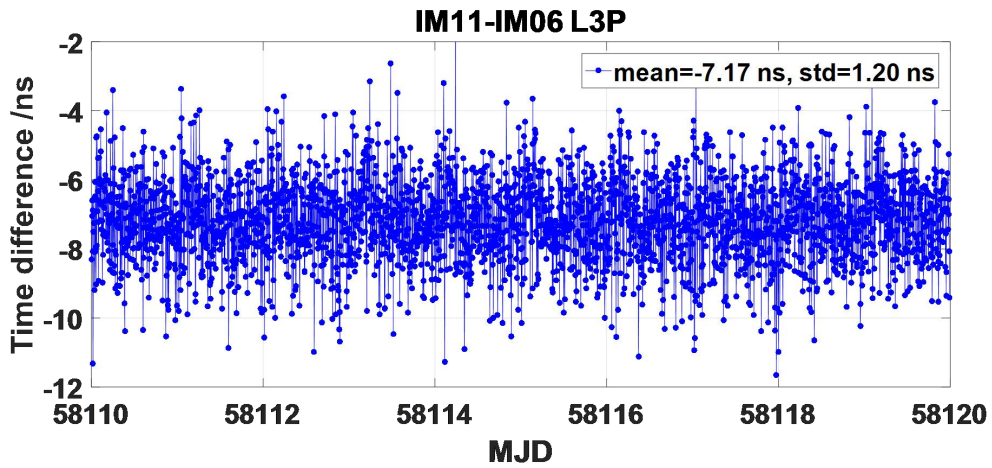

Figure 13. CCD between IM11 and IM06 at NIM(L3P)

2. Calibration on site

HKO1-IM09

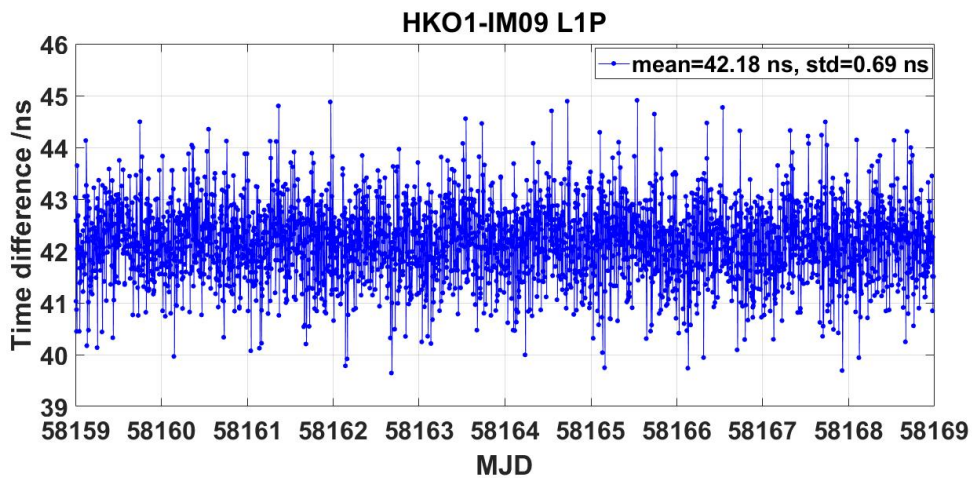

Figure 14. CCD between IM09 and HKO1 at HKO (L1P)

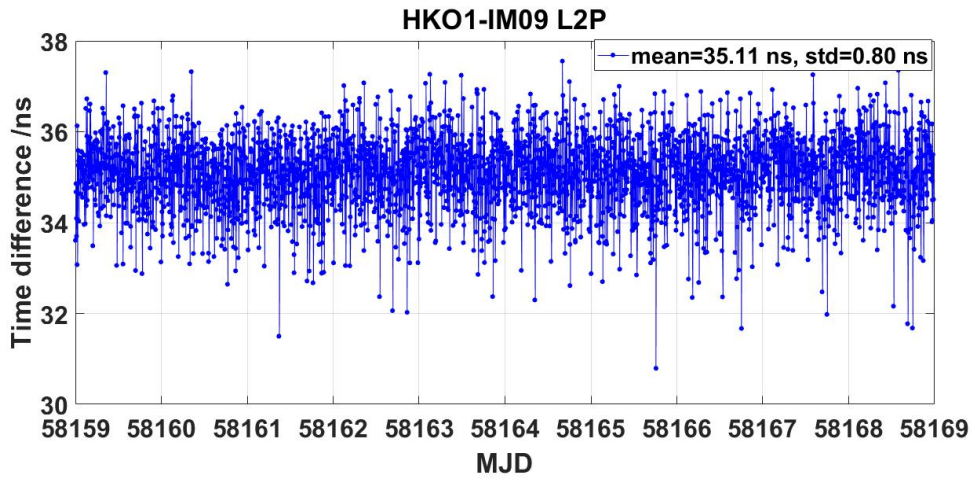

Figure 15. CCD between IM09 and HKO1 at HKO(L2P)

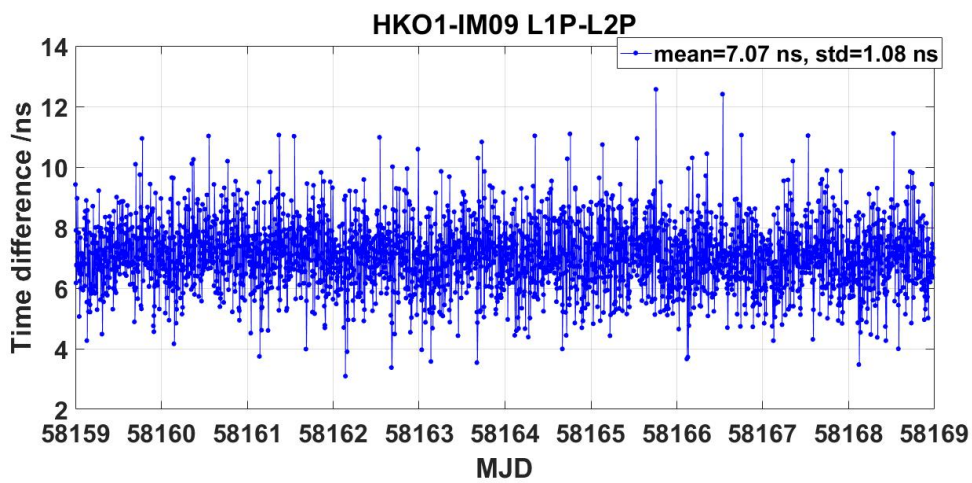

Figure 16. CCD between IM09 and HKO1 at HKO(L1P-L2P)

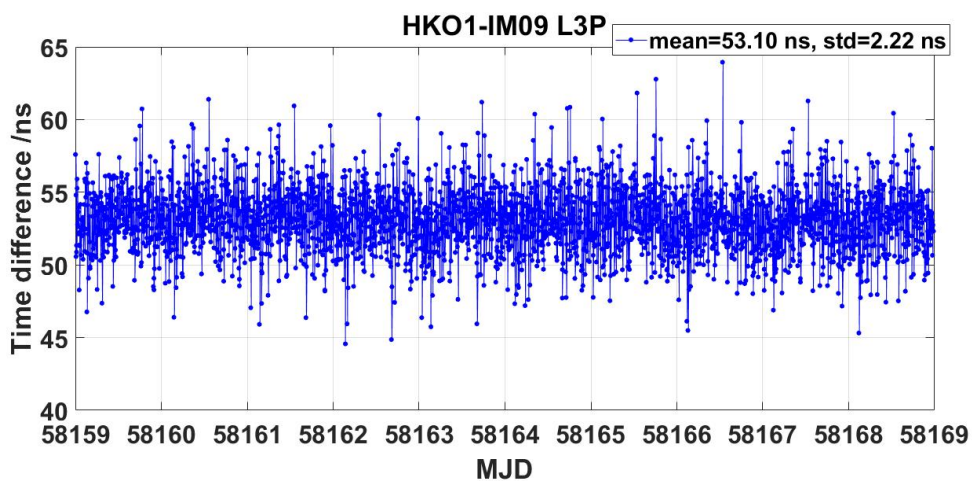

Figure 17. CCD between IM09 and HKO1 at HKO(L3P)

HKO1-IM11

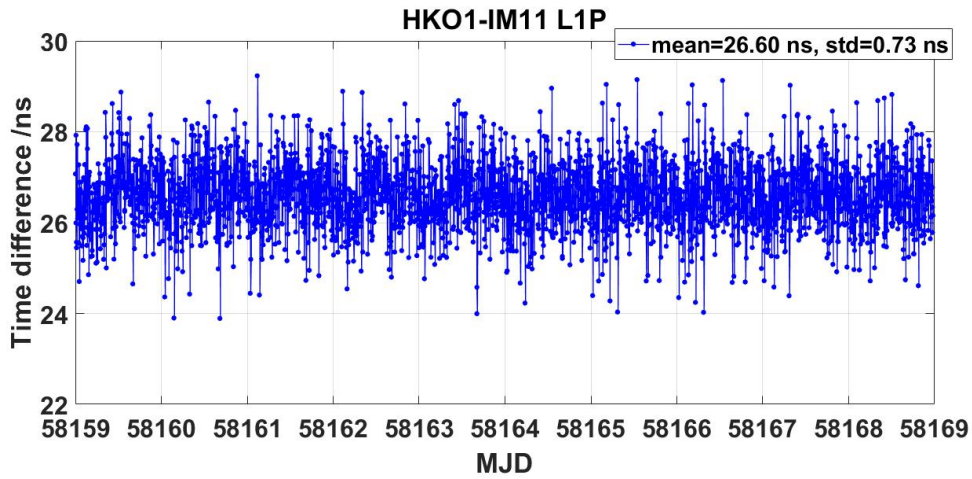

Figure 18. CCD between IM11 and HKO1 at HKO(L1P)

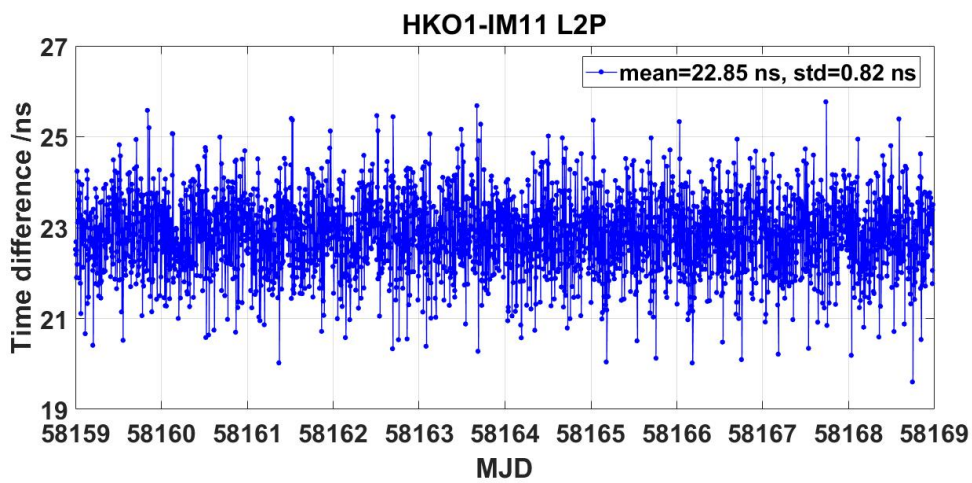

Figure 19. CCD between IM11 and HKO1 at HKO(L2P)

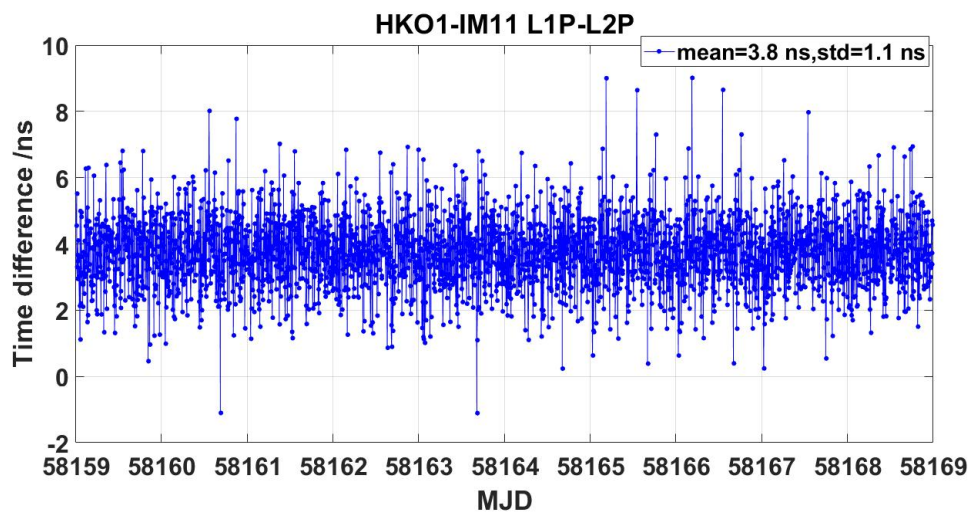

Figure 20. CCD between IM11 and HKO1 at HKO(L1P-L2P)

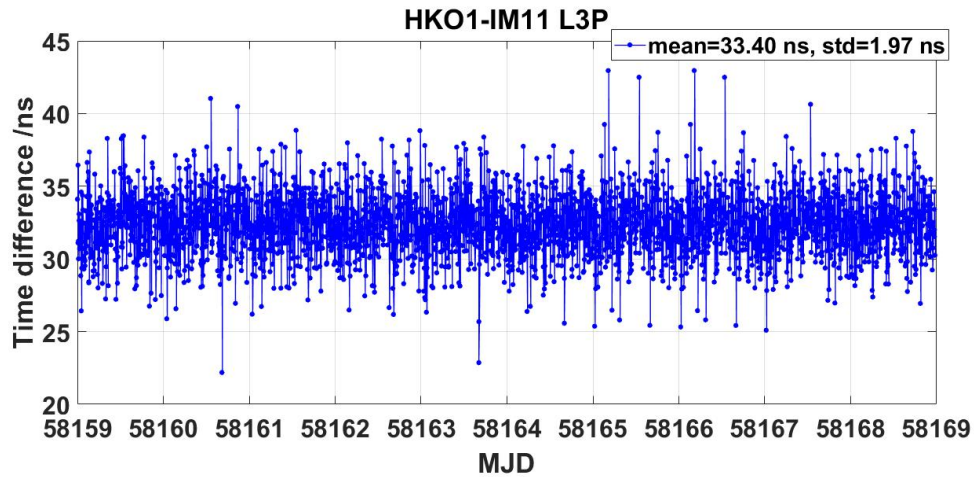

Figure 21. CCD between IM11 and HKO1 at HKO(L3P)

HKO2-IM09

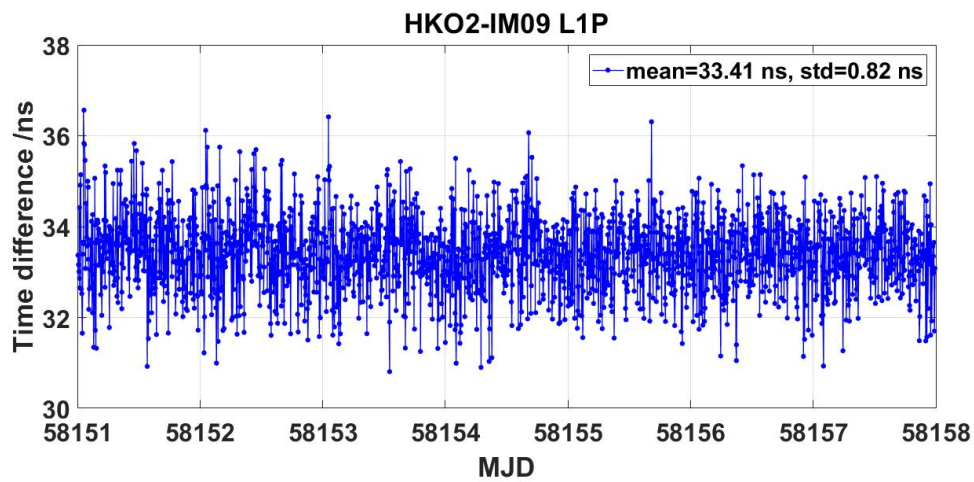

Figure 22. CCD between IM09 and HKO2 at HKO(L1P)

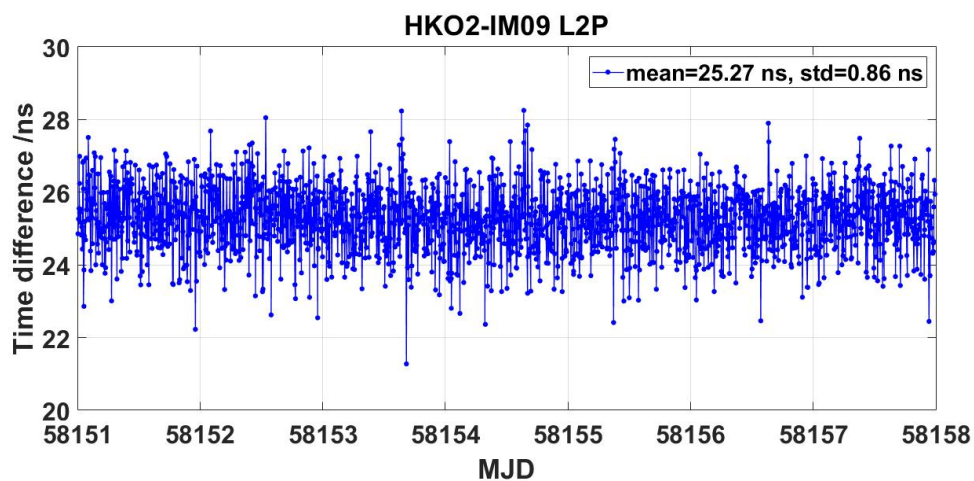

Figure 23. CCD between IM09 and HKO2 at HKO(L2P)

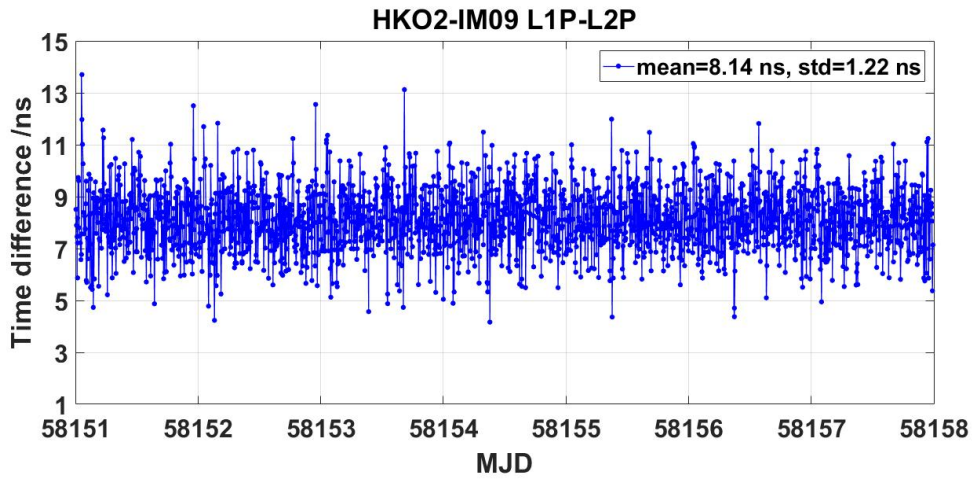

Figure 24. CCD between IM09 and HKO2 at HKO(L1P-L2P)

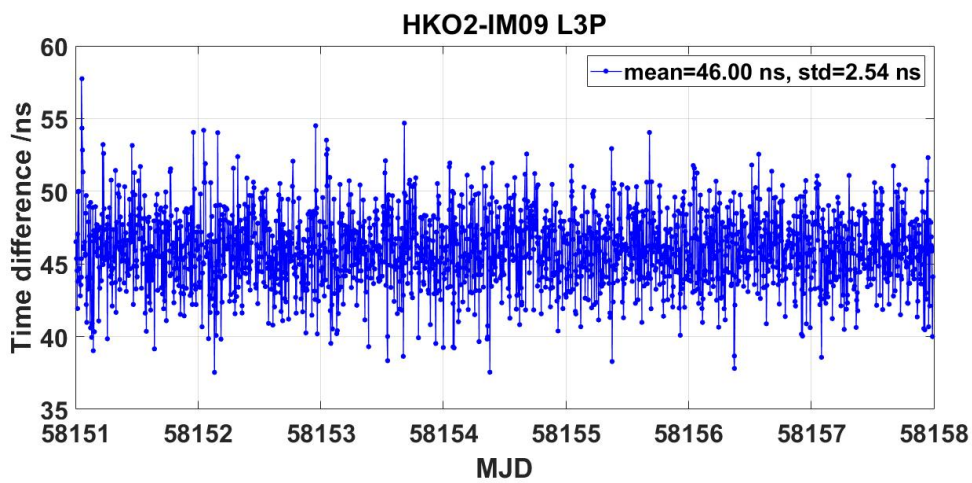

Figure 25. CCD between IM09 and HKO2 at HKO(L3P)

HKO2-IM11

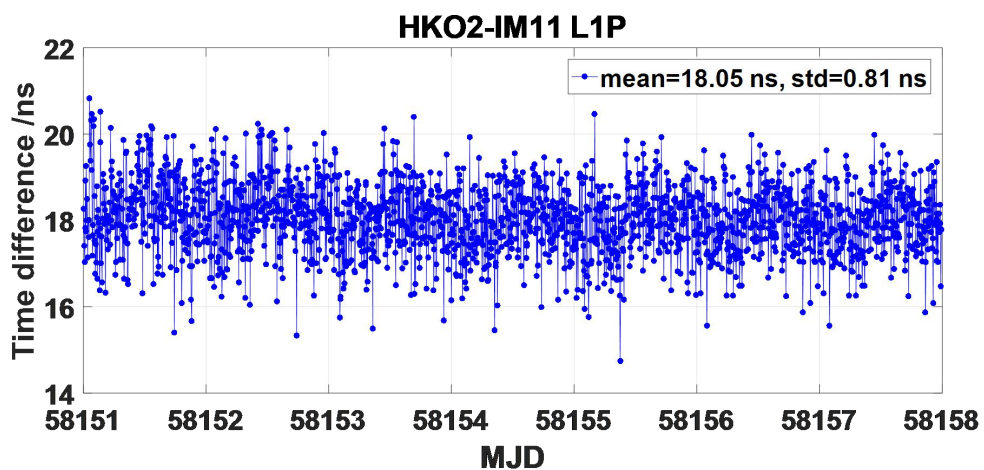

Figure 26. CCD between IM11 and HKO2 at HKO(L1P)

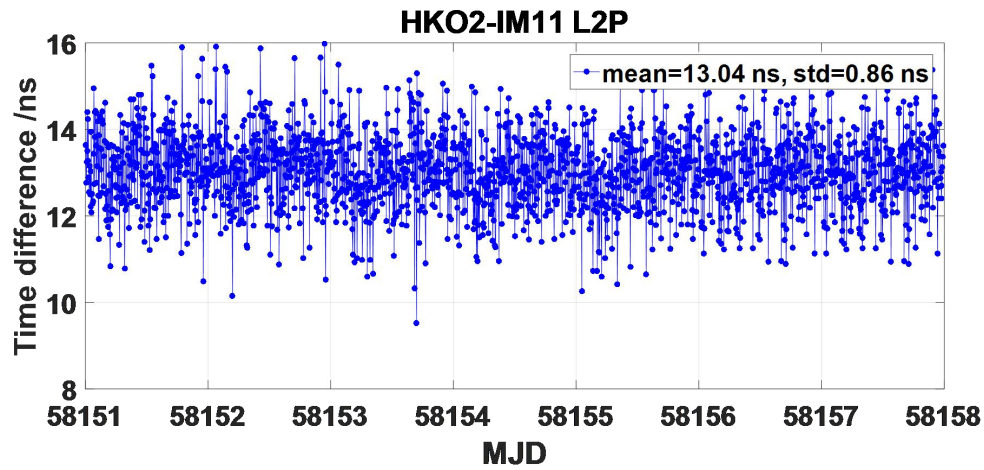

Figure 27. CCD between IM11 and HKO2 at HKO(L2P)

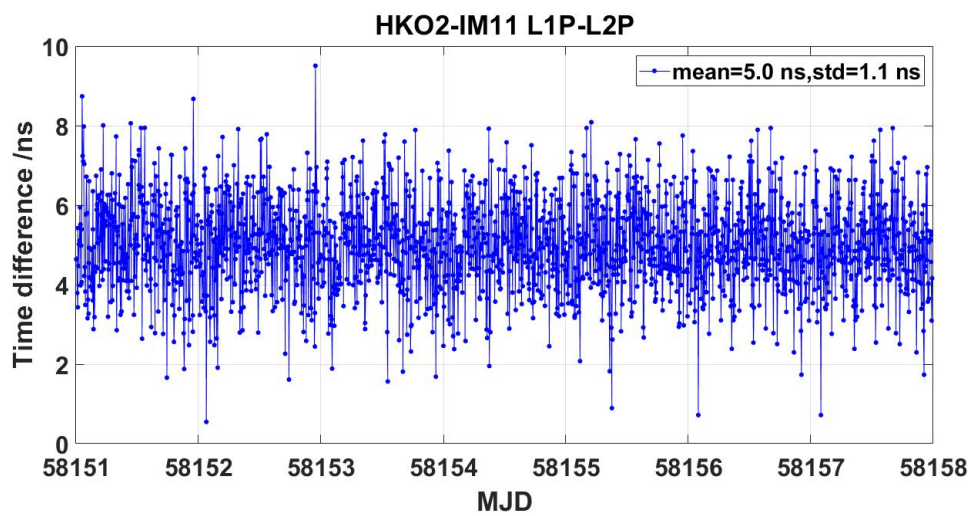

Figure 28. CCD between IM11 and HKO2 at HKO(L1P-L2P)

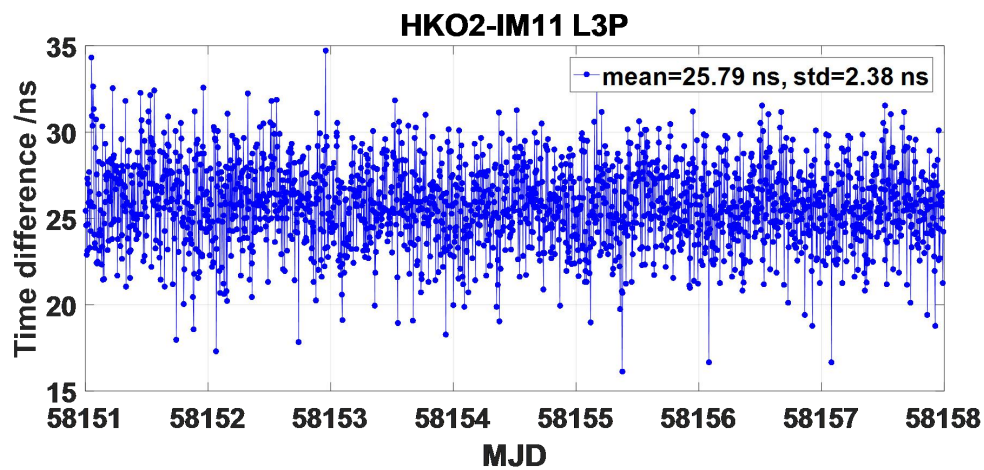

Figure 29. CCD between IM11 and HKO2 at HKO(L3P)

3. Closure CCD after calibration IM09-IM06

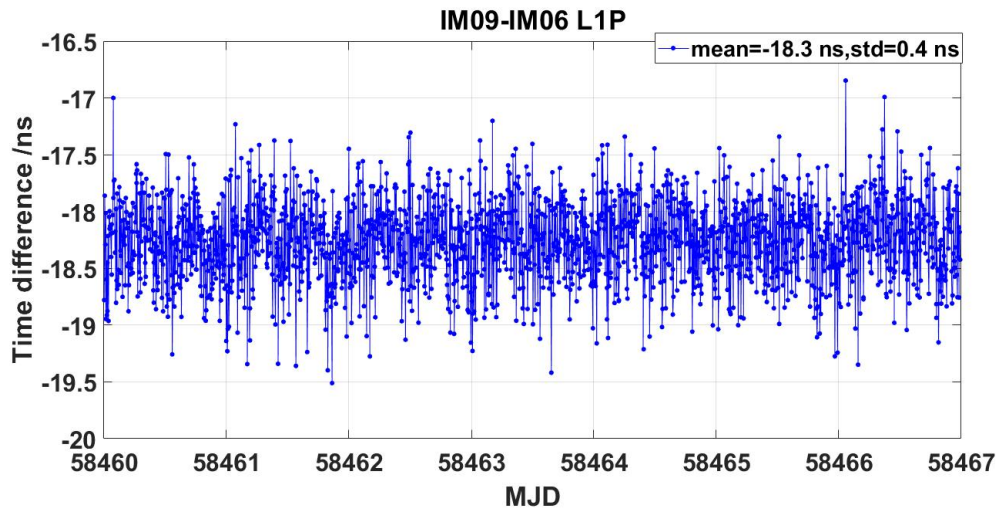

Figure 30. CCD between IM09 and IM06 at NIM(L1P)

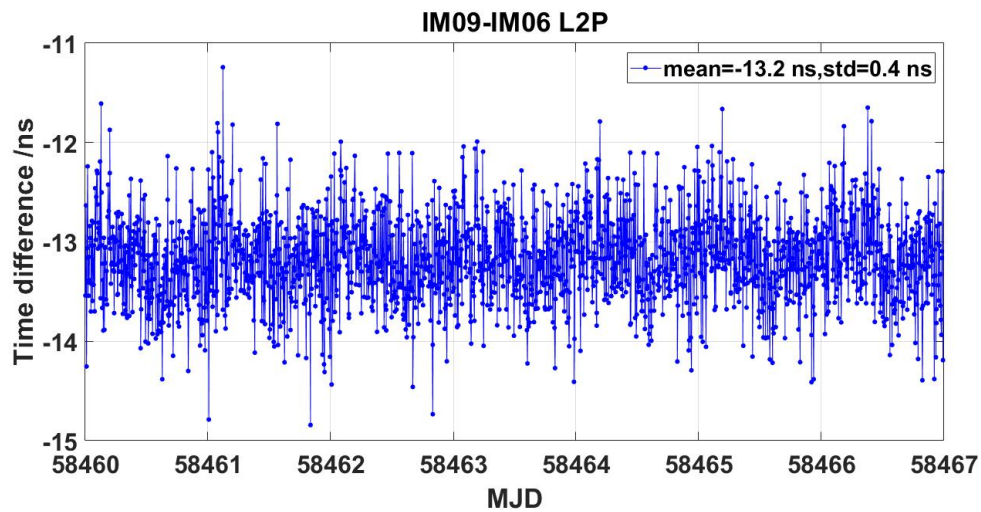

Figure 31. CCD between IM09 and IM06 at NIM(L2P)

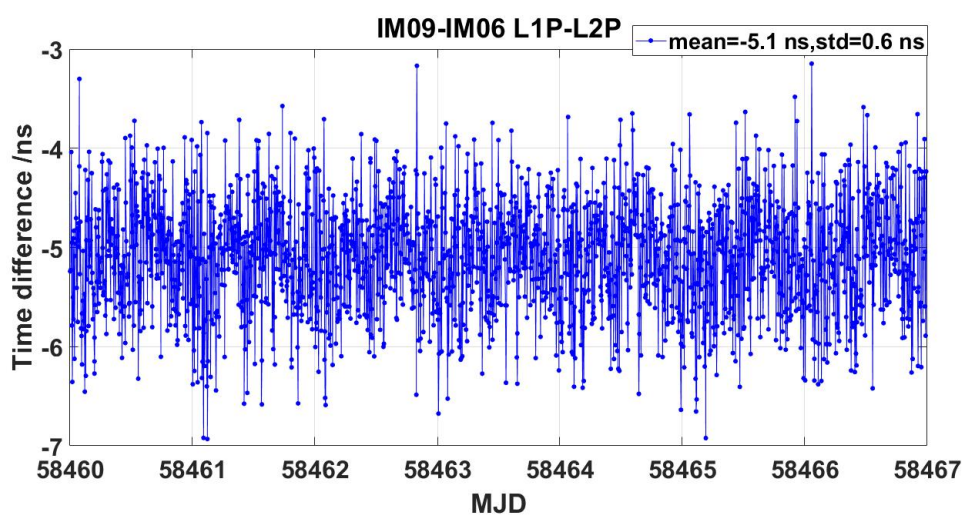

Figure 32. CCD between IM09 and IM06 at NIM(L1P-L2P)

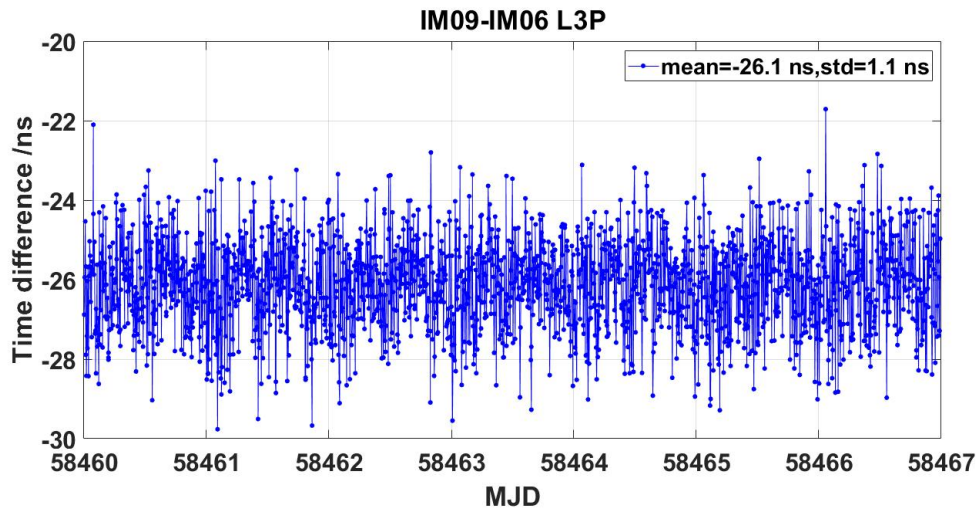

Figure 33. CCD between IM09 and IM06 at NIM(L3P)

IM11-IM06

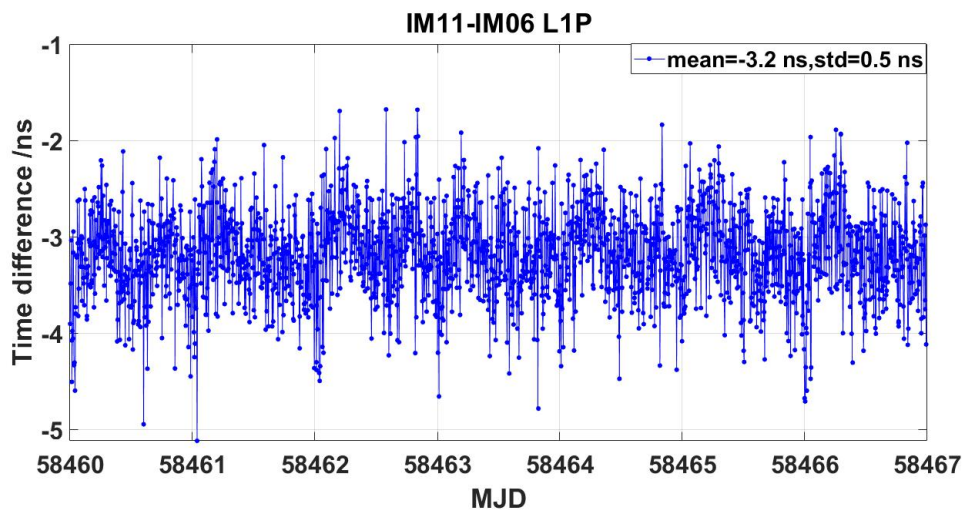

Figure 34. CCD between IM11 and IM06 at NIM(L1P)

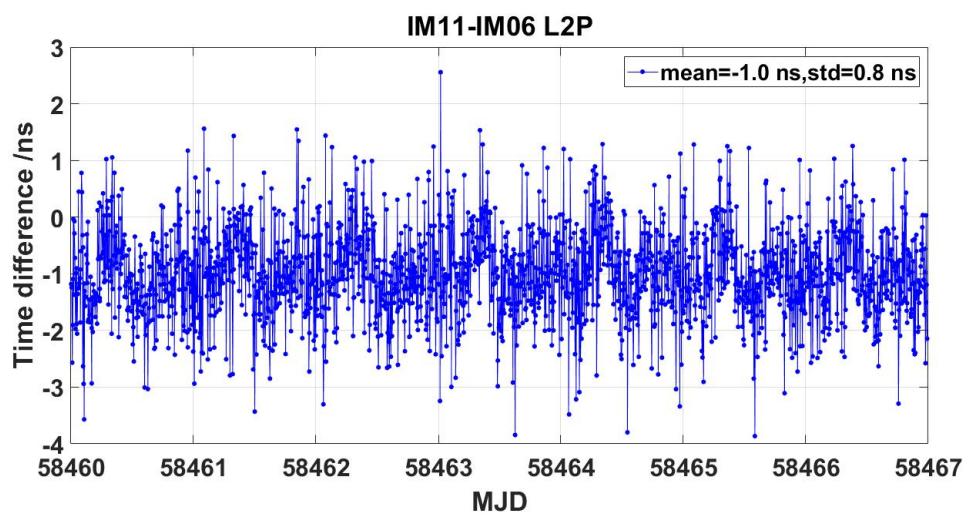

Figure 35. CCD between IM11 and IM06 at NIM(L2P)

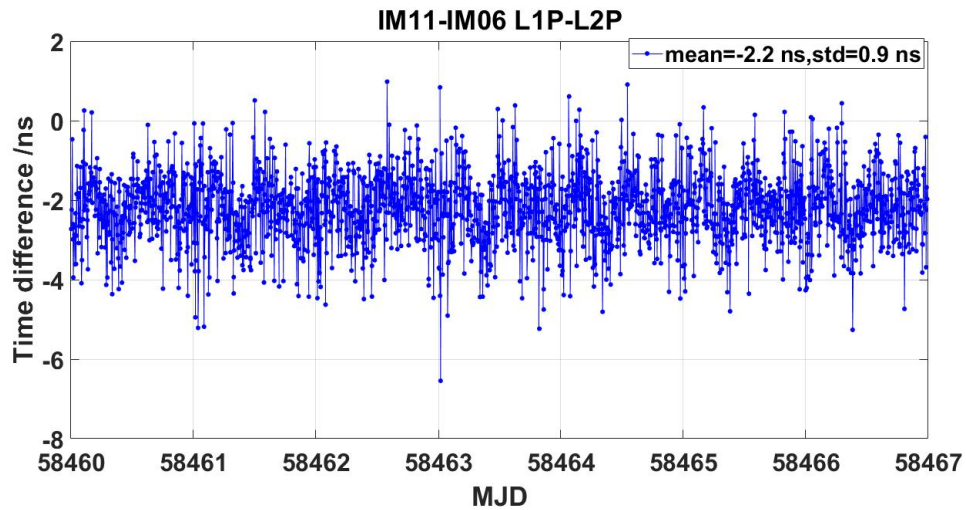

Figure 36. CCD between IM11 and IM06 at NIM(L1P-L2P)

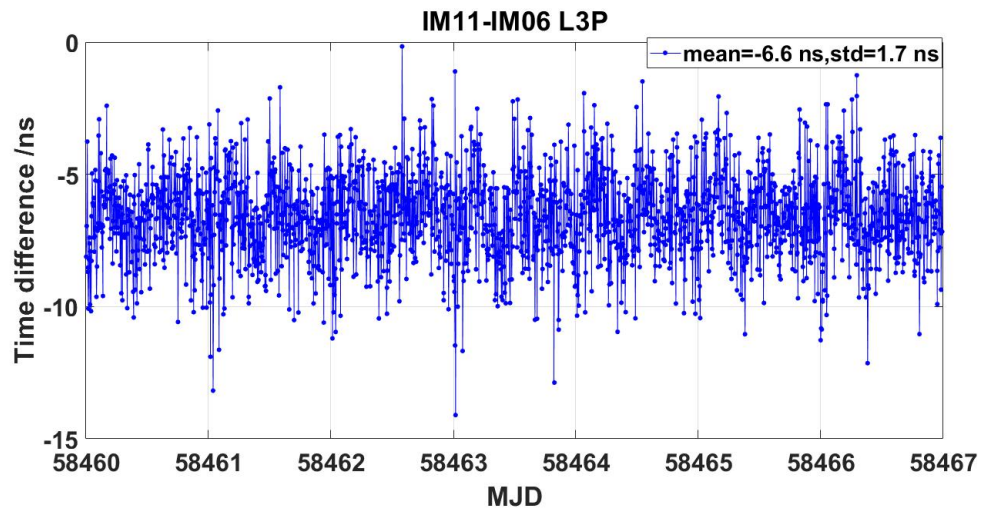

Figure 37. CCD between IM11 and IM06 at NIM(L3P)

Annex 2. CCD results for SCL

1. Start CCD before calibration

IM09-IM06

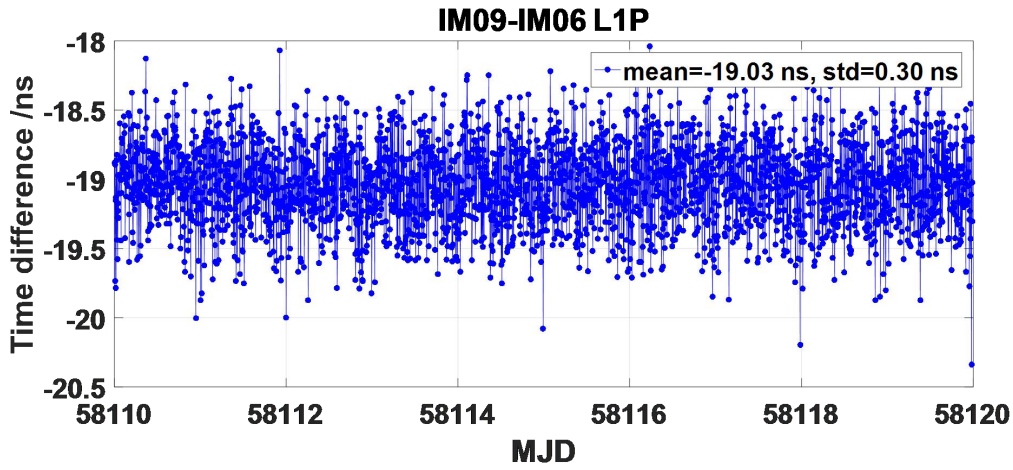

Figure 38. CCD between IM20 and IM06 at NIM(L1P)

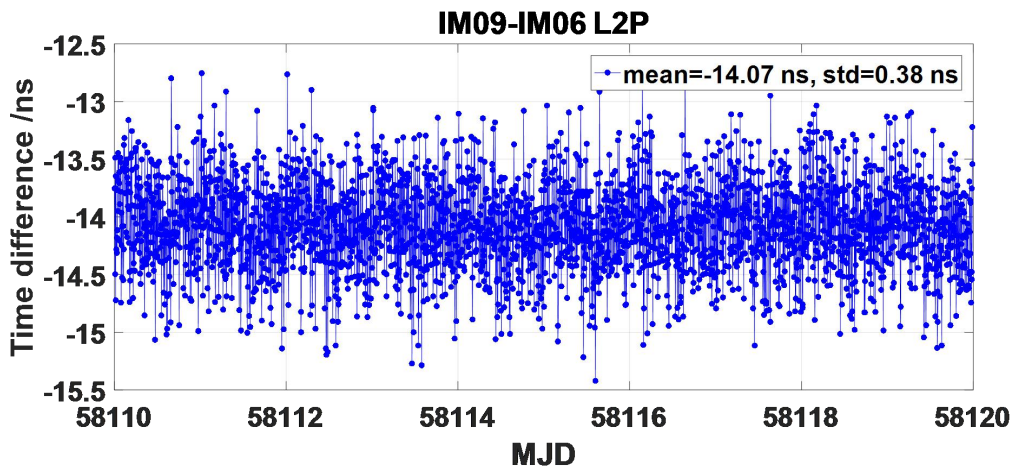

Figure 39. CCD between IM09 and IM06 at NIM(L2P)

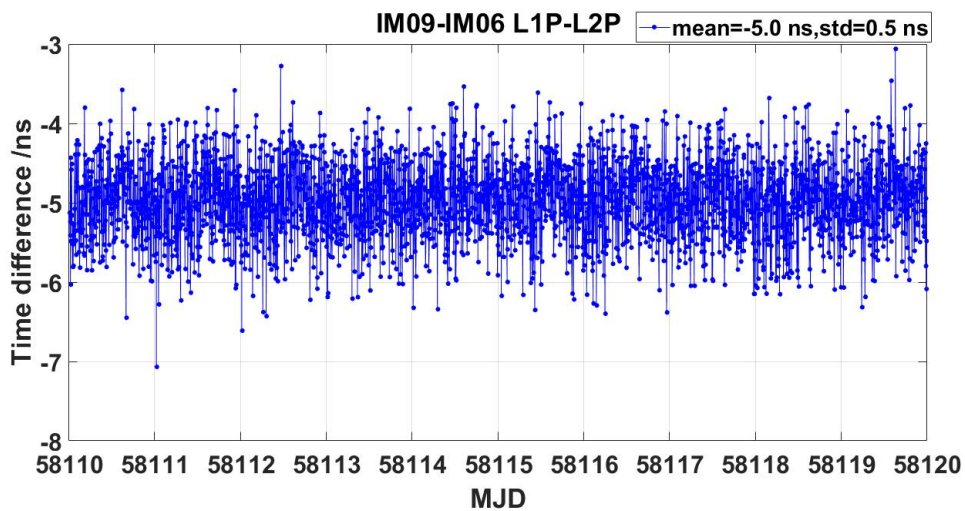

Figure 40. CCD between IM09 and IM06 at NIM(L1P-L2P)

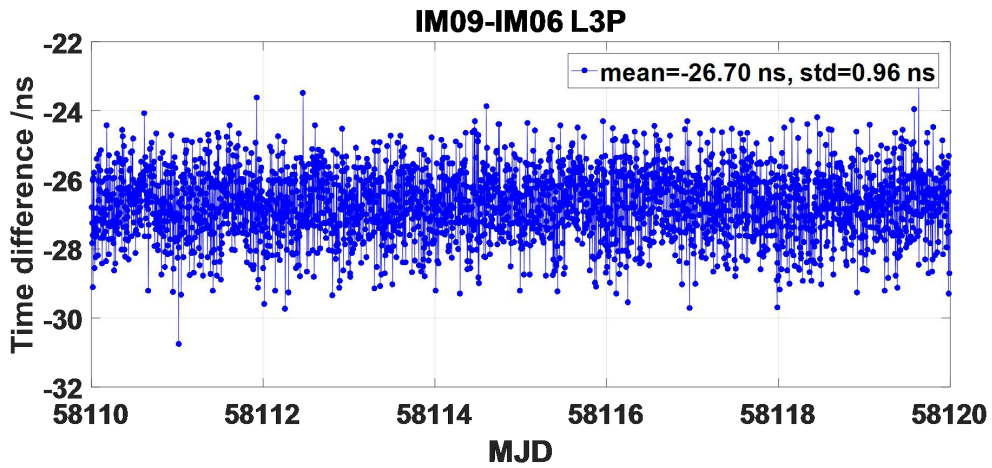

Figure 41. CCD between IM09 and IM06 at NIM(L3P)

2. Calibration on site

SCL2-IM09

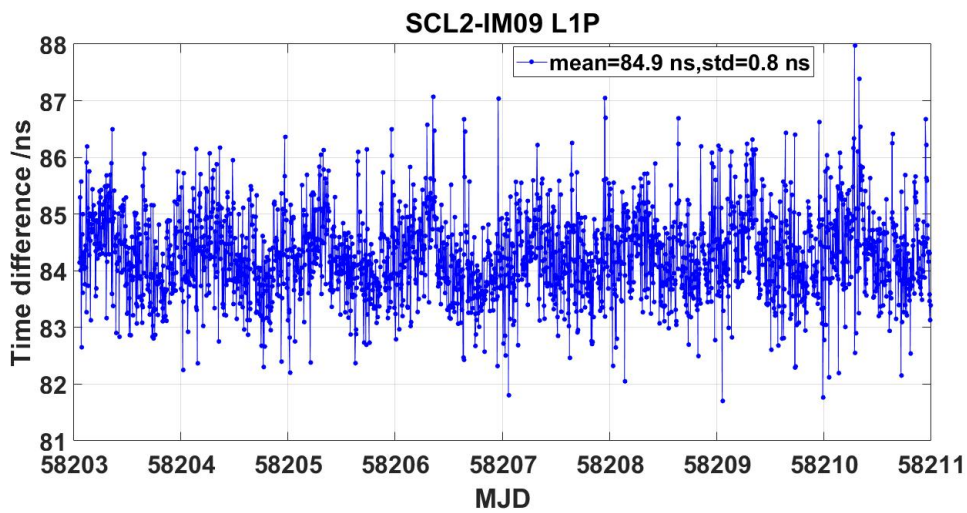

Figure 42. CCD between SCL2 and IM09 at SCL (L1P)

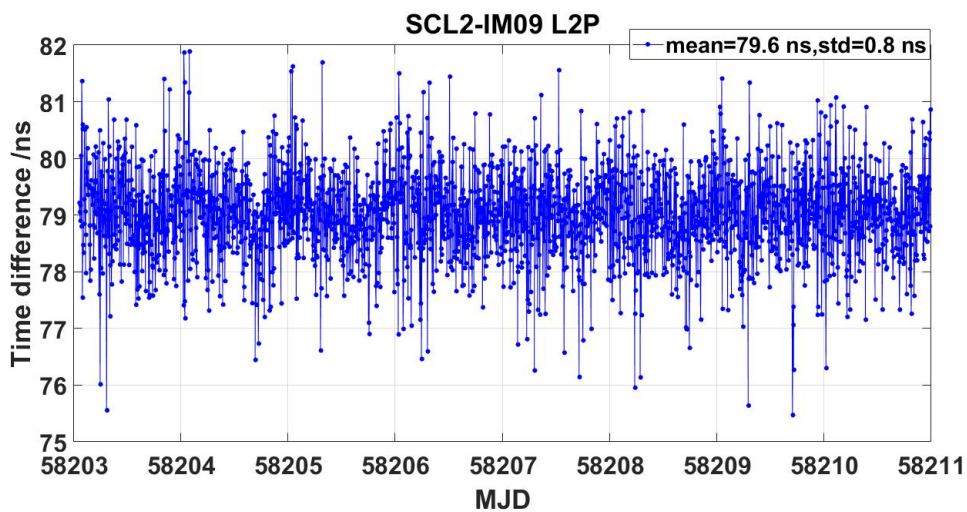

Figure 43. CCD between SCL2 and IM09 at SCL (L2P)

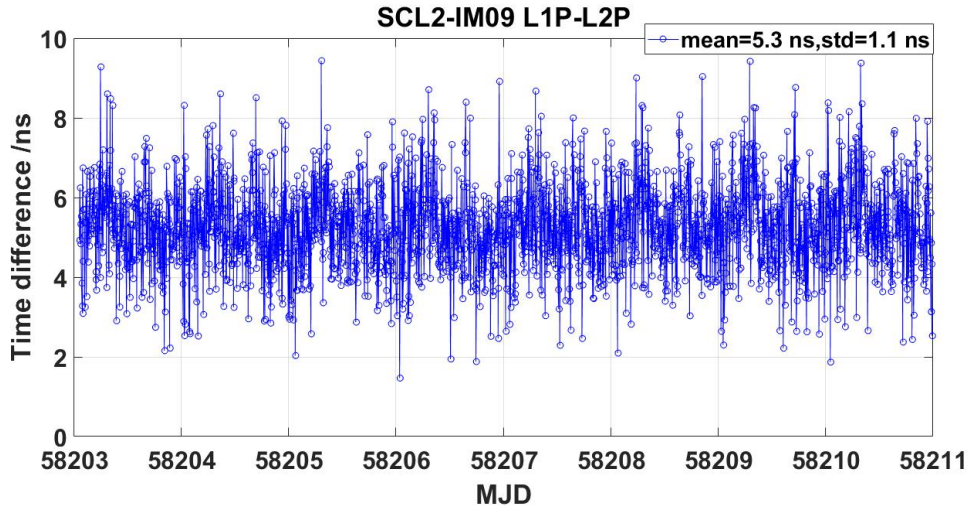

Figure 44. CCD between SCL2 and IM09 at SCL (L1P-L2P)

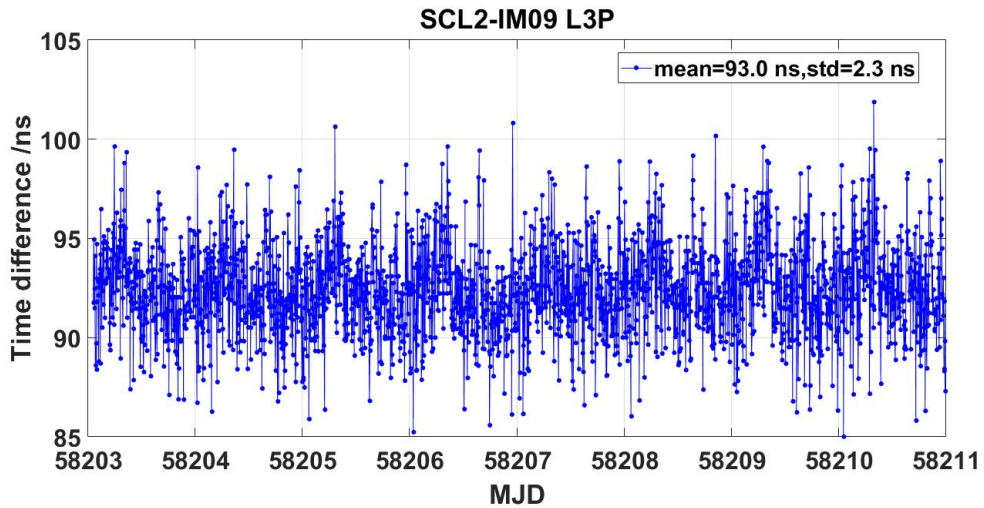

Figure 45. CCD between SCL2 and IM09 at SCL (L3P)

3. Closure CCD after calibration

IM09-IM06

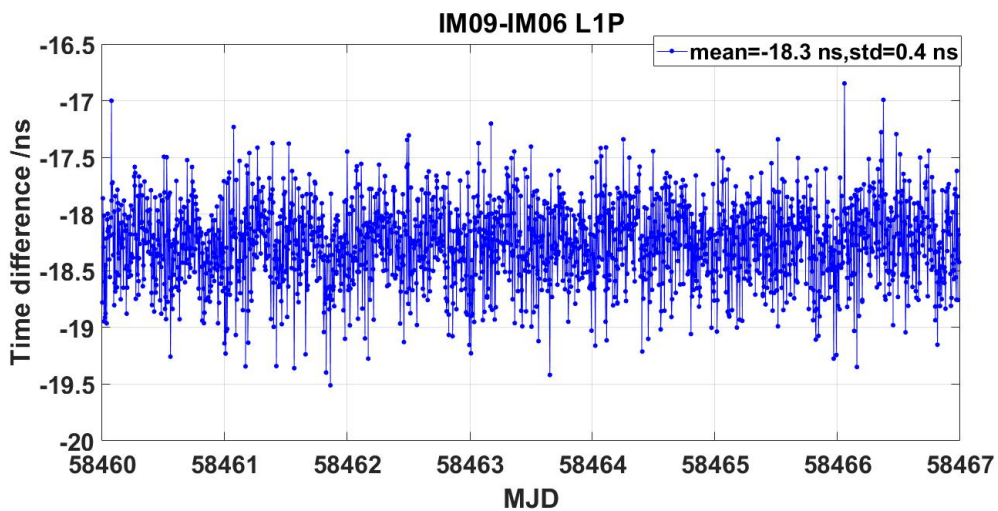

Figure 46. CCD between IM09 and IM06 at NIM(L1P)

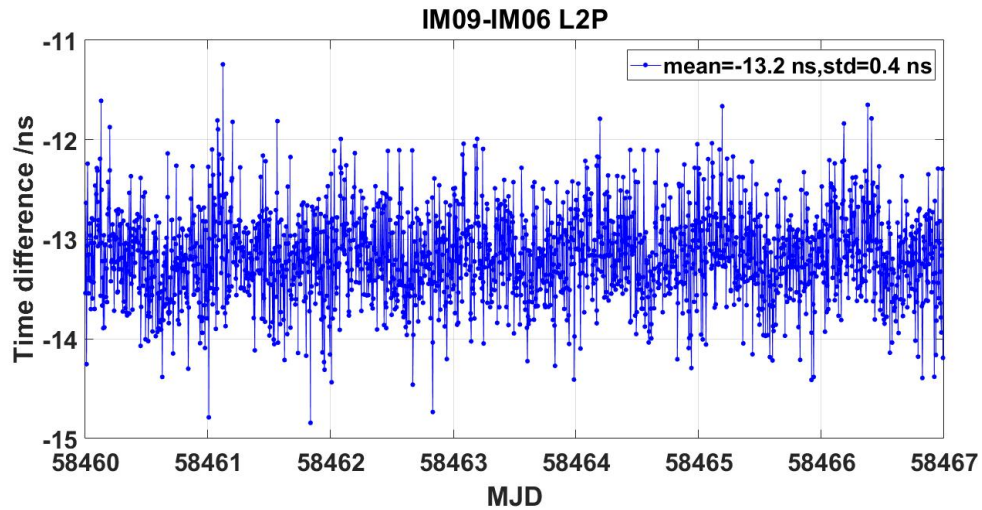

Figure 47. CCD between IM09 and IM06 at NIM(L2P)

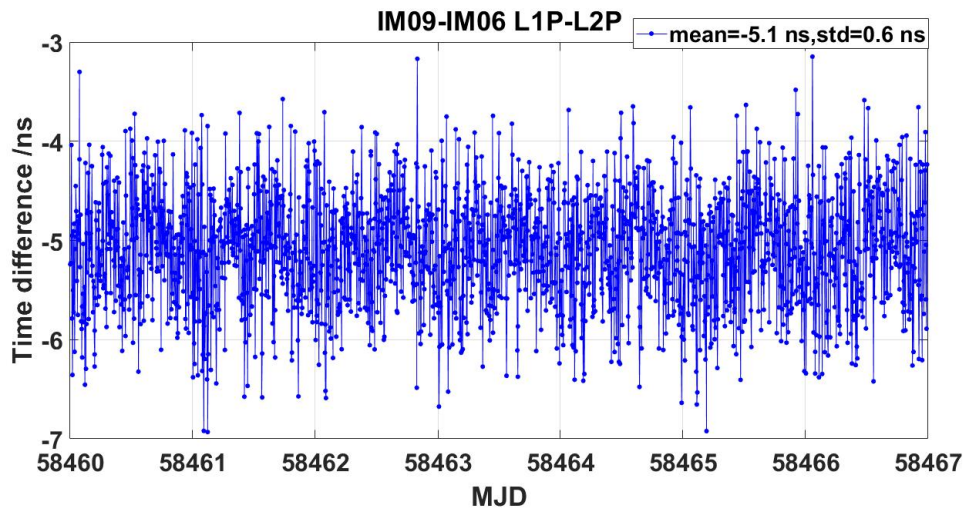

Figure 48. CCD between IM09 and IM06 at NIM(L1P-L2P)

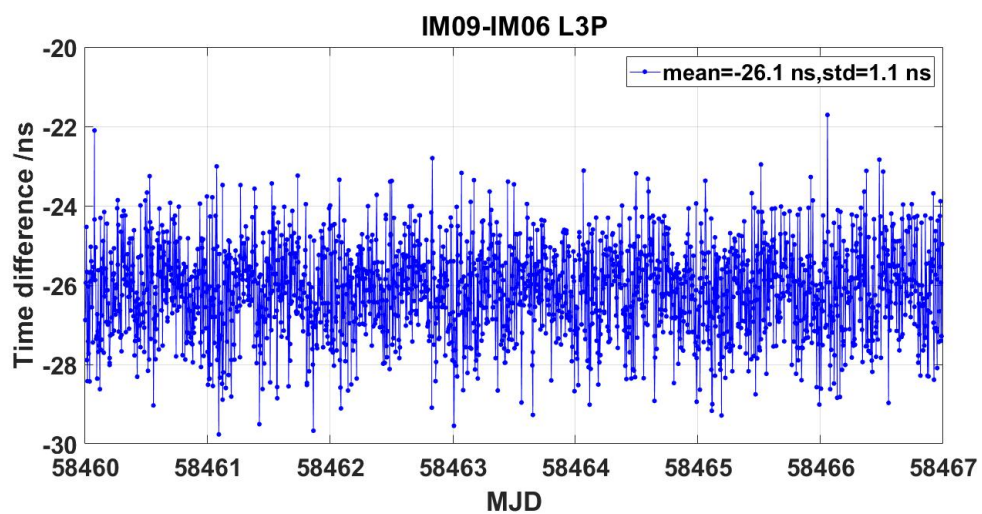

Figure 49. CCD between IM09 and IM06 at NIM(L3P)

Annex 3 - Information Sheet

(to be repeated for each calibrated system)

Laboratory:	HKO	
Date and hour of the beginning of measurements:	2018-02-10 00:00 UTC	
Date and hour of the end of measurements:	2018-02-26 00:00 UTC	
Information on the system		
	Local:	Travelling:
4-character BIPM code	hko1	
Receiver maker and type: Receiver serial number:	Piktime TTS-4, SN: 126	
1 PPS trigger level /V:	0.5	
Antenna cable maker and type: Phase stabilised cable (Y/N):	CNT, CNT-400 N	
Length outside the building /m:	5 (estimated)	
Antenna maker and type: Antenna serial number:	JAVAD RingAnt-G3T SN: 00577	
Temperature (if stabilised) /°C	36	
Measured delays /ns		
	Local:	Travelling:
Delay from local UTC to receiver 1 PPS-in:	7.92ns	
Delay from 1 PPS-in to internal Reference (if different):	4.78	
Antenna cable delay:	333.89	
Splitter delay (if any):	--	
Additional cable delay (if any):	--	
Data used for the generation of CGGTTS files		
INT DLY (GPS) /ns:	-22.50 (L1C)	
INT DLY (GLONASS) /ns:	-228.06 (L1C)	
CAB DLY /ns:	333.89	
REF DLY /ns:	7.92	
Coordinates reference frame:	ITRF	
Latitude or X /m:	-2417749.20	
Longitude or Y /m:	+5386168.63	
Height or Z /m:	+2405440.42	

General information	
Rise time of the local UTC pulse	<5ns
Is the laboratory air conditioned	Y
Set temperature value and uncertainty:	22°C±1
Set humidity value and uncertainty:	40%±5

(1) For a trip with closure, not needed if the traveling equipment is used in the same set-up throughout.

Diagram of the experiment set-up

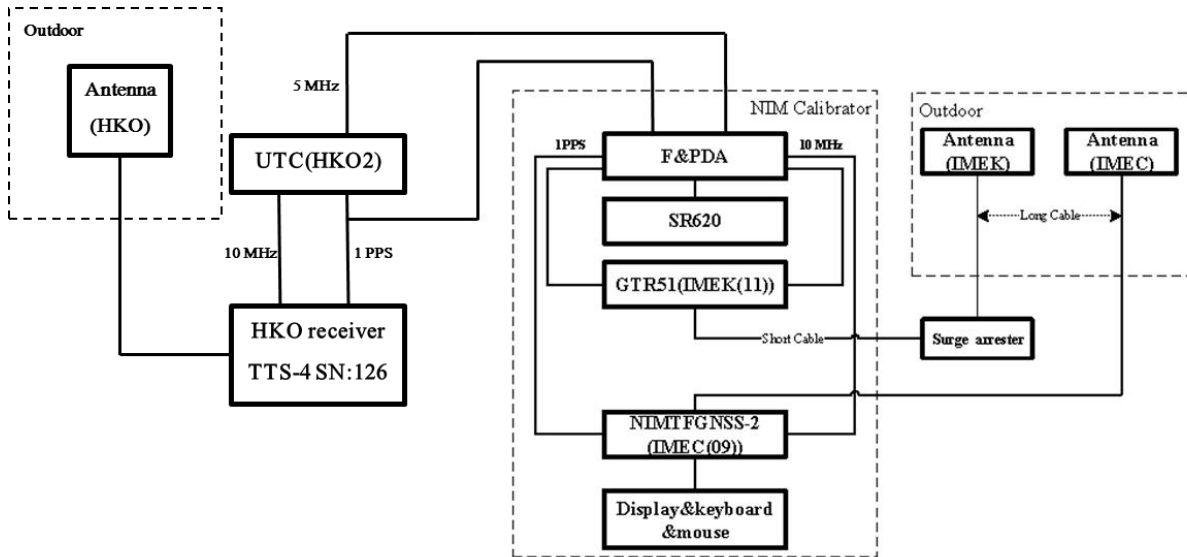

Log of Events / Additional Information

(to be repeated for each calibrated system)

Laboratory:	HKO
Date and hour of the beginning of measurements:	2018-02-02 00:00 UTC
Date and hour of the end of measurements:	2018-02-09 00:00 UTC

Information on the system

	Local:	Travelling:
4-character BIPM code	hko2	
Receiver maker and type: Receiver serial number:	Piktime TTS-4, SN: 133	
1 PPS trigger level /V:	0.5	
Antenna cable maker and type: Phase stabilised cable (Y/N):	HELIAX FSJ4-50B N	
Length outside the building /m:	20 (estimated)	
Antenna maker and type: Antenna serial number:	JAVAD RingAnt-G3T SN: 00587	

Temperature (if stabilised) /°C	44	
Measured delays /ns		
	Local:	Travelling:
Delay from local UTC to receiver 1 PPS-in:	7.92ns	
Delay from 1 PPS-in to internal Reference (if different):	-6.43	
Antenna cable delay:	423.33	
Splitter delay (if any):	--	
Additional cable delay (if any):	--	
Data used for the generation of CGGTTS files		
INT DLY (GPS) /ns:	-19.66	
INT DLY (GLONASS) /ns:	-225.07 (L1C)	
CAB DLY /ns:	423.33 (L1C)	
REF DLY /ns:	7.92	
Coordinates reference frame:	ITRF	
Latitude or X /m:	-2417748.93	
Longitude or Y /m:	+5386168.70	
Height or Z /m:	+2405440.68	
General information		
Rise time of the local UTC pulse	<5ns	
Is the laboratory air conditioned	Y	
Set temperature value and uncertainty:	22°C±1	
Set humidity value and uncertainty:	40%±5	

(1) For a trip with closure, not needed if the traveling equipment is used in the same set-up throughout.

Diagram of the experiment set-up

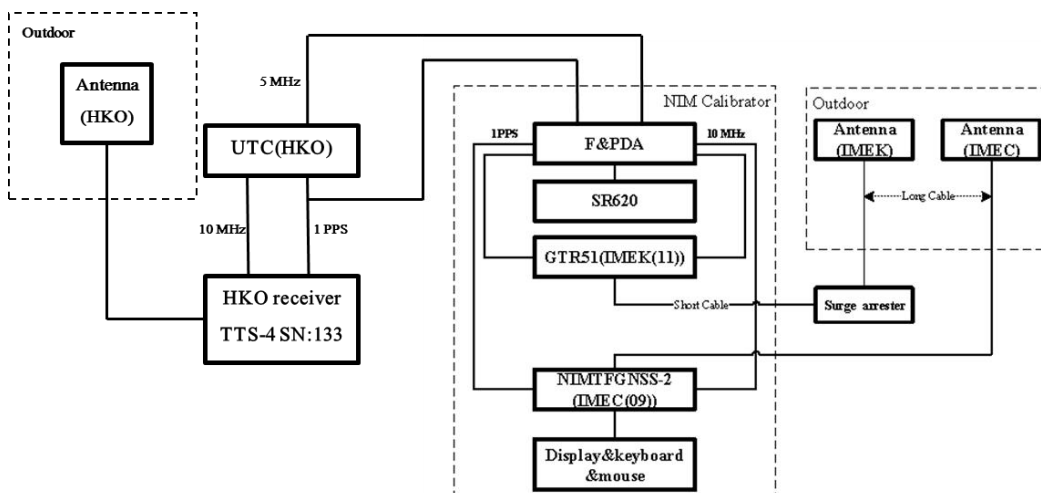

Log of Events / Additional Information

(to be repeated for each calibrated system)

Laboratory:	SCL	
Date and hour of the beginning of measurements:		
Date and hour of the end of measurements:		
Information on the system		
	Local:	Travelling:
4-character BIPM code	SCL	NIM
Receiver maker and type:	Septentrio PolarX5TR-3022579	NIM NIM-TF-GNSS-2J
Receiver serial number:	s/n: 4701243	s/n: 201401
1 PPS trigger level /V:	N/A	N/A
Antenna cable maker and type:	RFS LCF78-50JA and Suhner Sucoflex 104 cables	RFS LCF78-50JA and Suhner Sucoflex 104 cables
Phase stabilised cable (Y/N):	N	N
Length outside the building /m:	39 m	39 m
Antenna maker and type:	Septentrio Polant-X MF AT1675-540S	AERAT1675-200
Antenna serial number:	s/n: 12220	s/n: 5098
Temperature (if stabilised) /°C	N/A	N/A
Measured delays /ns		
	Local:	Travelling:
Delay from local UTC to receiver 1 PPS-in:	10 ns	10 ns
Delay from 1 PPS-in to internal Reference (if different):	N/A	N/A
Antenna cable delay:	512 ns	526.6 ns
Splitter delay (if any):	N/A	N/A
Additional cable delay (if any):	N/A	N/A
Data used for the generation of CGGTTS files		
INT DLY (GPS) /ns:	0 ns	
INT DLY (GLONASS) /ns:	N/A	
CAB DLY /ns:	512 ns	
REF DLY /ns:	10 ns	
Coordinates reference frame:	WGS84	
Latitude or X /m:	22° 16' 47.4780" N	

Longitude or Y /m:	114° 10' 22.7533" E
Height or Z /m:	185.4 m
General information	
Rise time of the local UTC pulse	5.8 ns
Is the laboratory air conditioned	Yes
Set temperature value and uncertainty:	(23±1) °C
Set humidity value and uncertainty:	(45±8) %

(1) For a trip with closure, not needed if the traveling equipment is used in the same set-up throughout.

Measurement scheme

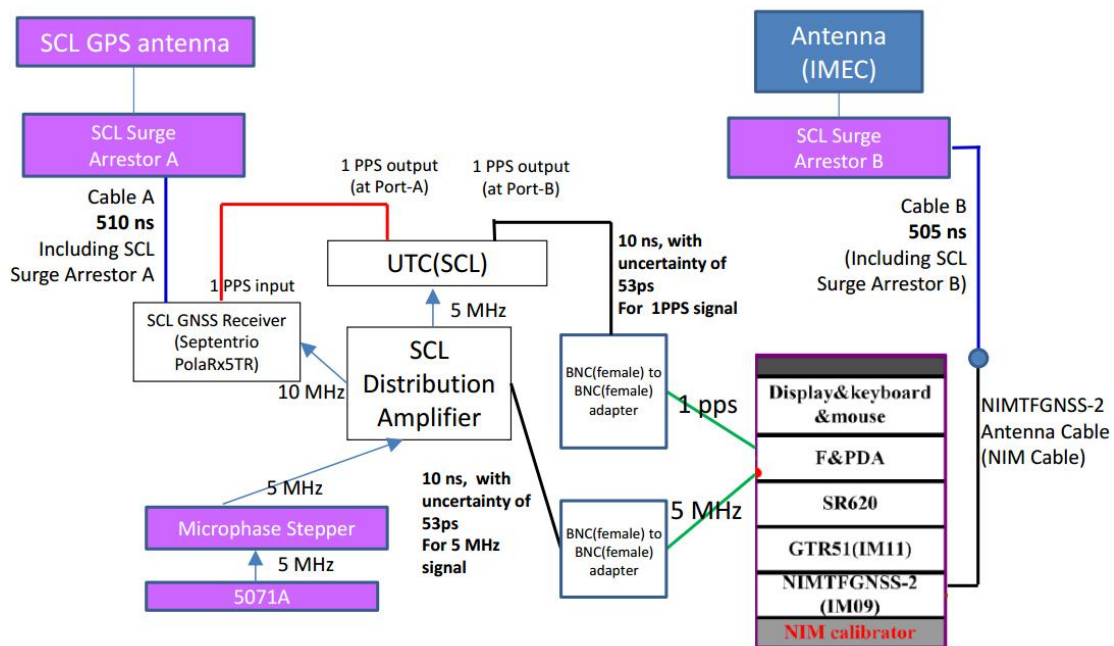

Annex 4 – TDEV for CCD results at HKO

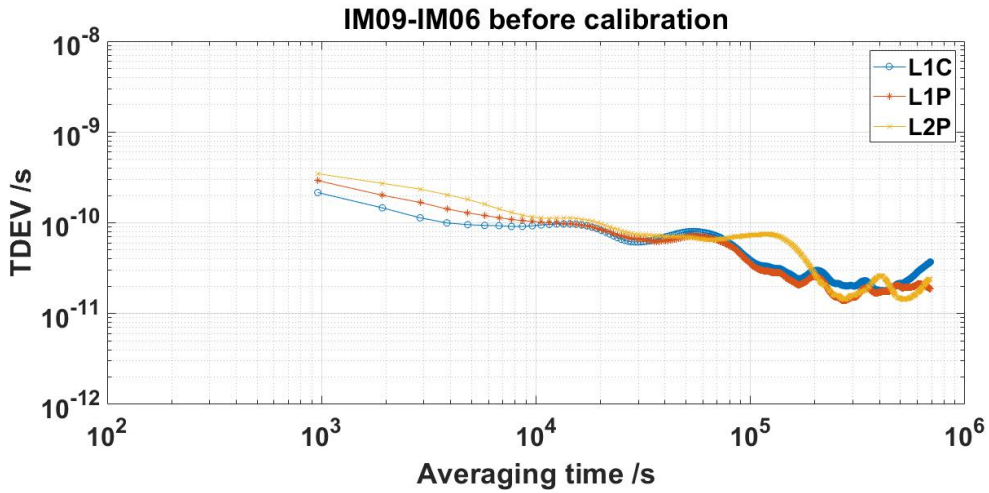

Figure 50. TDEV between IM09 and IM06 receivers at NIM before calibration

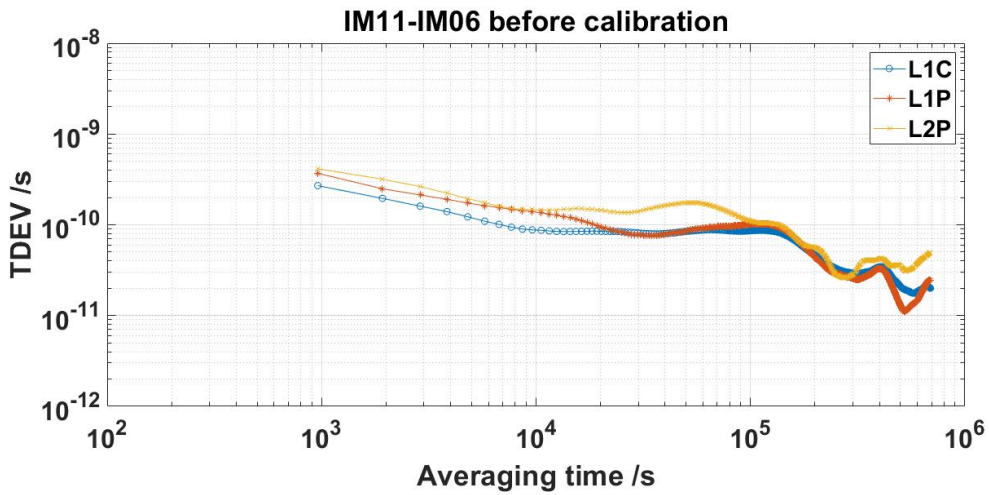

Figure 51. TDEV between IM11 and IM06 receivers at NIM before calibration

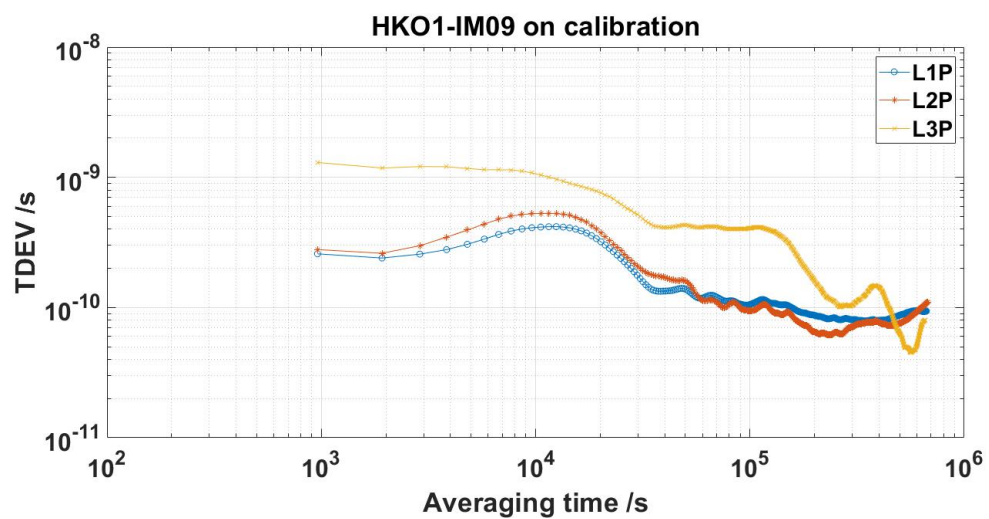

Figure 52. TDEV between HKO1 and IM09 receivers at HKO on calibration

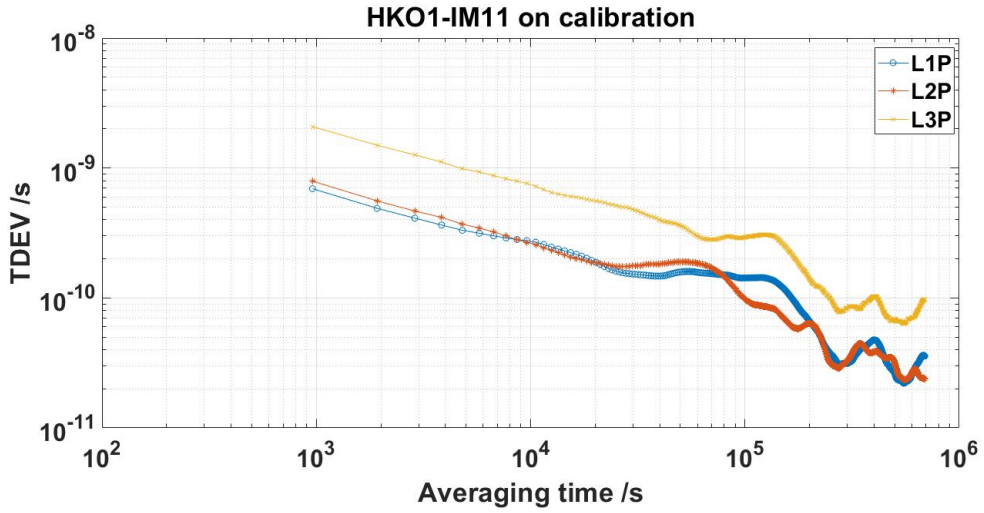

Figure 53. TDEV between HKO1 and IM011 receivers at HKO on calibration

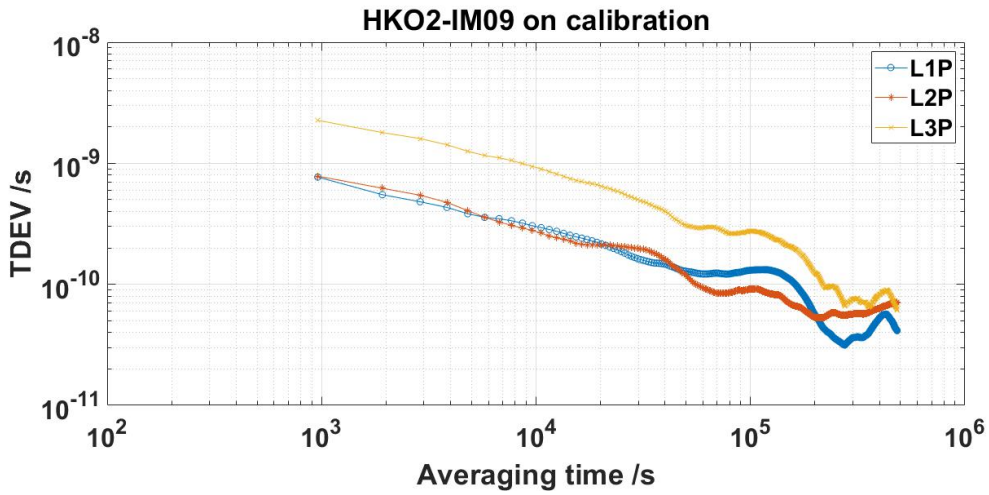

Figure 54. TDEV between HKO2 and IM09 receivers at HKO on calibration

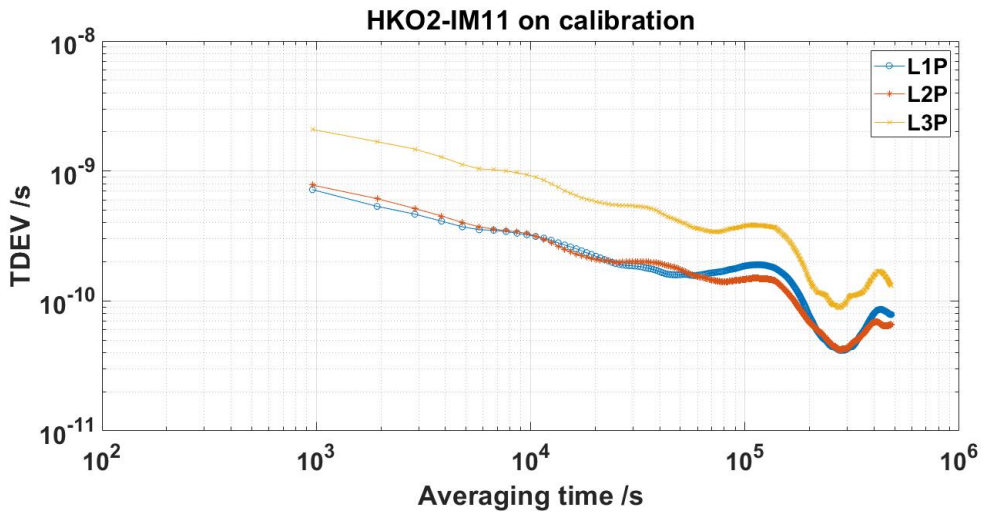

Figure 55. TDEV between HKO2 and IM11 receivers at HKO on calibration

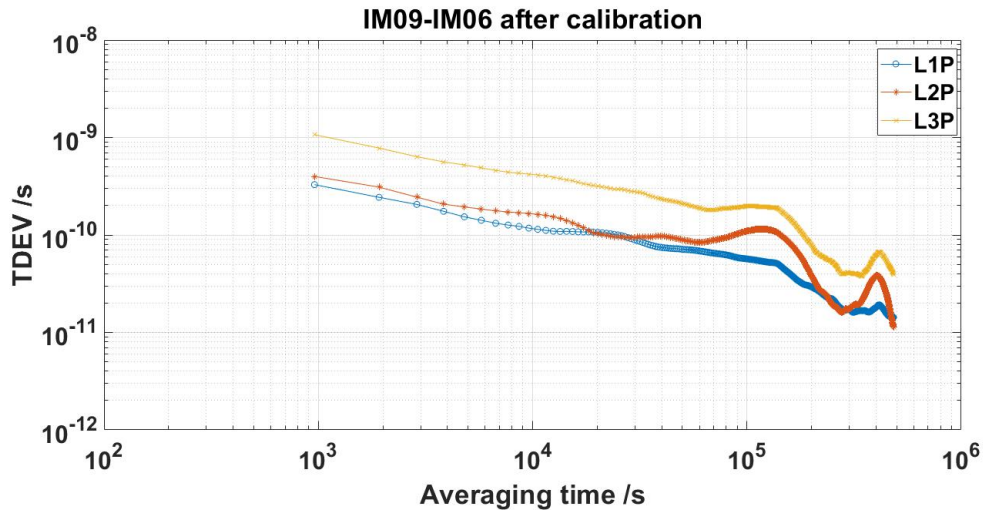

Figure 56. TDEV between IM09 and IM06 receivers at NIM after calibration

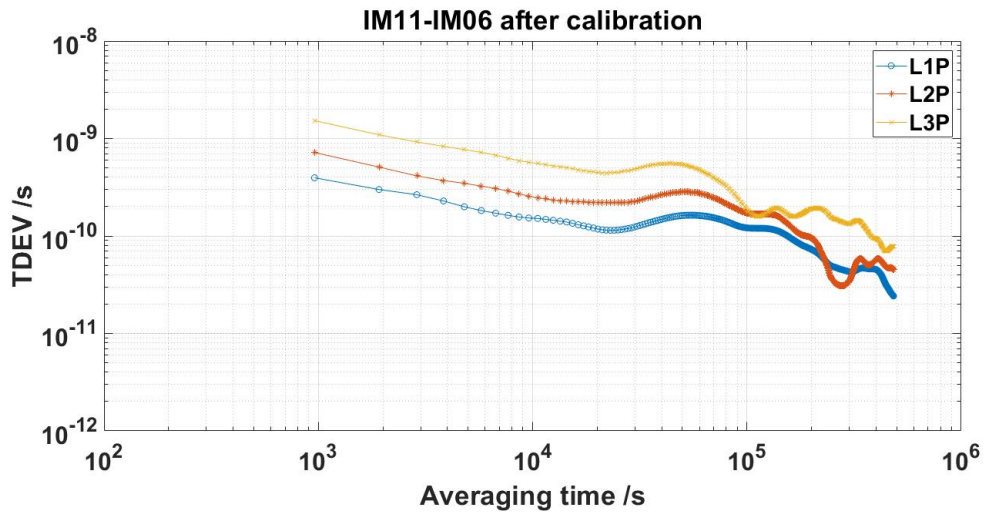

Figure 57. TDEV between IM11 and IM06 receivers at NIM after calibration

Annex 5 – TDEV for CCD results at SCL

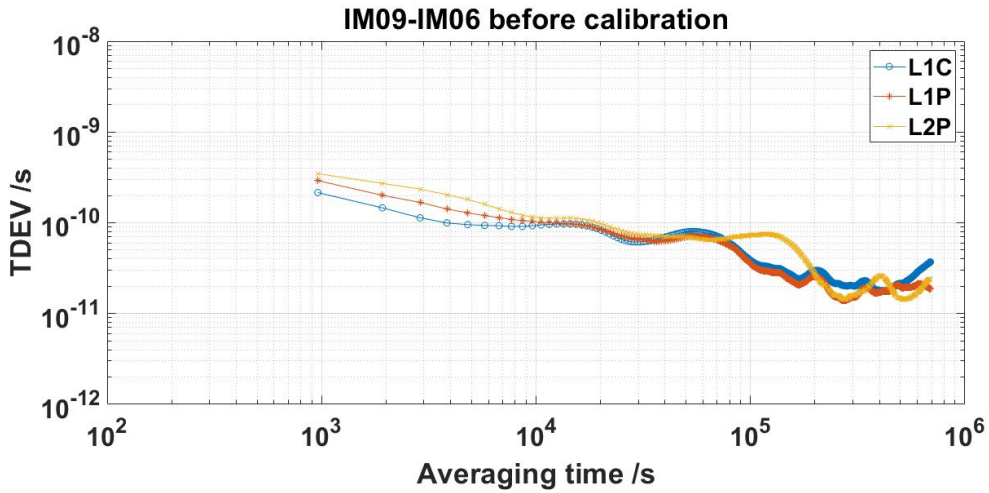

Figure 58. TDEV between IM09 and IM06 receivers at NIM before calibration

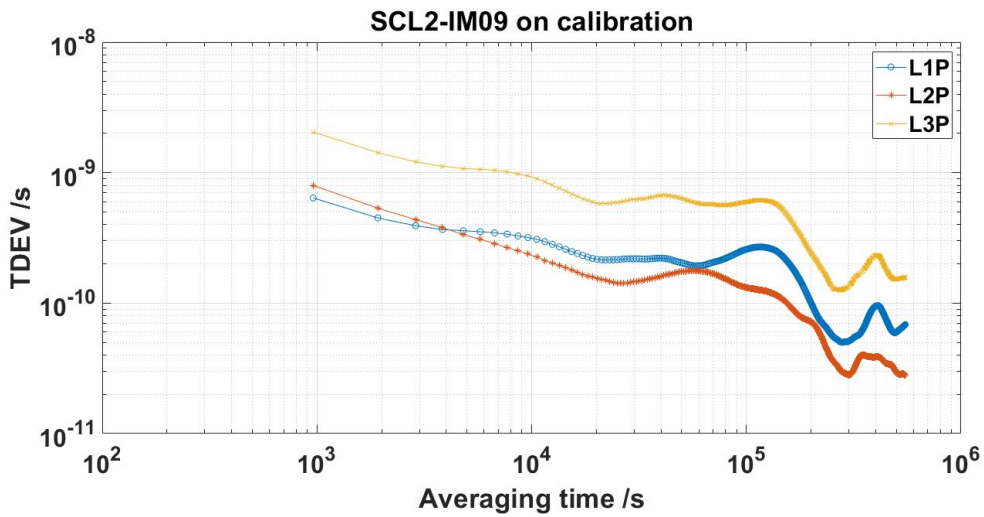

Figure 59. TDEV between SCL2 and IM09 receivers at SCL during calibration

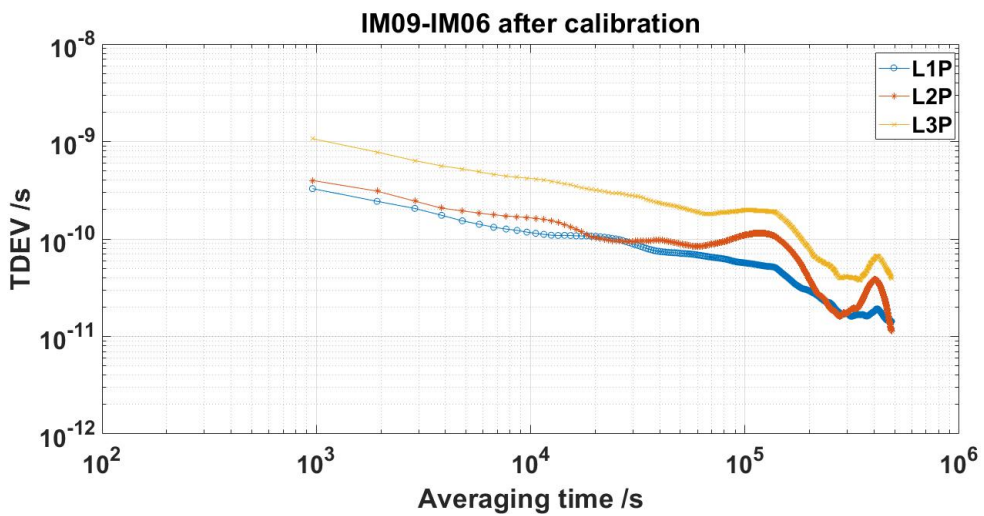

Figure 60. TDEV between IM09 and IM06 receivers at NIM after calibration