

# GNSS CALIBRATION REPORT

## G1G2\_1012\_2016

Prepared by: Andreas Bauch (PTB)  
Head, Time Dissemination  
Working Group

Approved by: Jürgen Becker (PTB)  
QM-responsible of PTB  
Time and Frequency  
Department

Authorized by: BIPM\_

Project : EURAMET\_PT\_B\_G1G2  
Code: 1012\_2016  
Version: 1.1  
Date: 12/09/2016

## TABLE OF CONTENTS

LIST OF TABLES AND FIGURES.....	3
REFERENCES.....	5
ACRONYMS .....	6
EXECUTIVE SUMMARY .....	7
1. CONTENTS OF THE REPORT .....	8
2. PARTICIPANTS AND SCHEDULE .....	9
3. CALIBRATION PROCEDURE.....	11
4. CHARACTERIZATION OF PTB EQUIPMENT .....	14
5. RESULTS OF COMMON-CLOCK SET-UP IN PTB: PERIOD 1 .....	17
6. OPERATION OF PTBT IN DLR.....	18
7. OPERATION OF PTBT AT METAS .....	23
8. OPERATION OF PTBT AT VSL.....	26
9. OPERATION OF PTBT AT BEV .....	29
10. OPERATION OF PTBT AT PTB: SECOND PERIOD.....	33
10.1. SUMMARY.....	33
11. INT DLY UNCERTAINTY ESTIMATION .....	35
12. FINAL RESULTS.....	39
ANNEX: BIPM CALIBRATION INFORMATION SHEETS.....	41

## LIST OF TABLES AND FIGURES

Table 2-1: List of participants .....	9
Table 2-2: Schedule of the campaign .....	9
Table 6-1: $\Delta$ INT DLY( $\Pi$ ) values and statistical properties obtained initially. ....	20
Table 6-2: Time instability of the $\Delta$ $\Pi$ -values obtained for the five GNSS receivers at DLR IKN with reference to receiver PTBT .....	21
Table 7-1: $\Delta$ INT DLY( $\Pi$ ) values and statistical properties obtained initially. TDEV values are estimates based on the graphs shown in Table 7-2. ....	25
Table 7-2: Time instability of the $\Delta$ $\Pi$ -values obtained for the two GNSS receivers at METAS with reference to receiver PTBT .....	25
Table 8-1: $\Delta$ INT DLY( $\Pi$ ) values and statistical properties obtained initially. TDEV values are estimates based on the graphs shown in Figure 8-3. ....	27
Table 8-2: Time instability of the $\Delta$ $\Pi$ -values obtained for the two GNSS receivers at VSL with reference to receiver PTBT .....	28
Table 9-1. $\Delta$ INT DLY( $\Pi$ ) values and statistical properties obtained initially. TDEV values are estimates based on the graphs shown in Figure 9-4. ....	31
Table 9-2. Time instability of the $\Delta$ $\Pi$ -values obtained for the two GNSS receivers at BEV with reference to receiver PTBT .....	31
Table 10-1: Result of common clock measurements at PTB .....	34
Table 11-1: Uncertainty contributions for the calibration of receiver delays .....	35
Table 11-2: Elevation dependence of GPS P3 time differences (REFYS) with PTBT at PTB .....	37
Table 12-1. Results of the Calibration Campaign G1G2_1012_2016, all values in ns.....	39
Figure 4-1: Common-clock common-view comparison between GPS receivers at PTB, daily mean values.....	14
Figure 4-2: UTC(PTB) reference point and 1 PPS signal distribution to PT02, PT03 and PTBT .....	15
Figure 4-3: UTC(PTB) signal distribution (5 MHz, 10 MHz, 20 MHz) to PT02, PT03 and PTBT.....	15
Figure 4-4: Installation of GNSS antennas at PTB.....	16
Figure 5-1: $\Delta$ $\Pi$ values obtained during the first common-clock set-up in PTB. ....	17
Figure 5-2: TDEV obtained for the two data sets shown in, $\Delta$ P1 left, $\Delta$ P2 right. ....	17
Figure 6-1: Scheme of the installation of the GNSS receivers at DLR IKN .....	18
Figure 6-2: Installation of the PTBT antenna on the DLR IKN antenna rack .....	19
Figure 6-3: $\Delta$ $\Pi$ -values recorded between PTBT and 5 GNSS receivers at DLR IKN. ....	19
Figure 6-4: $\Delta$ $\Pi$ -values recorded between PTBT and 5 GNSS receivers at DLR IKN, outliers and corrupted data removed .....	20
Figure 7-1: Scheme of the installation of the GNSS receivers at METAS.....	23
Figure 7-2: Installation of GNSS antennas on the METAS roof.....	24
Figure 7-3: $\Delta$ $\Pi$ -values recorded between PTBT and 2 GNSS receivers at METAS, one outlier removed .....	24
Figure 8-1: Scheme of the installation of the GNSS receivers at VSL.....	26
Figure 8-2: Installation of GNSS antennas on the VSL roof: from left to right: VSLG, VSLF, and PTBT.....	26
Figure 8-3: $\Delta$ $\Pi$ -values recorded between PTBT and 2 GNSS receivers at VSL .....	27
Figure 9-1. Scheme of the installation of the GNSS receivers at BEV .....	29
Figure 9-2. Installation of the PTBT antenna at BEV.....	29
Figure 9-3. Common-clock Common view comparison between the two receivers of BEV based on their original CGGTTS files.....	30
Figure 9-4. $\Delta$ $\Pi$ -values recorded between PTBT and 2 GNSS receivers at BEV .....	31
Figure 10-1. $\Delta$ $\Pi$ values obtained during the second common-clock set-up in PTB.....	33
Figure 10-2. TDEV obtained for the two data sets shown in, $\Delta$ P1 left, $\Delta$ P2 right.....	33
Figure 10-3. Common-clock common-view comparison spanning 5 months, daily mean values .....	34



## REFERENCES

REFERENCES	
RD01	BIPM report 1001-2014 V.1.9 13.07.2016, subject: Initial Group 1 calibration trip
RD02	BIPM guidelines for GNSS calibration, V3.0, 02/04/2015
RD03	BIPM TM.212 (G.Petit), Nov. 2012
RD04	J. Kouba, P. Heroux, 2002, <i>"Precise Point Positioning Using IGS Orbit and Clock Products,"</i> GPS Solutions, Vol 5, No. 2, 12-28
RD05	W. Lewandowski, C. Thomas, 1991, <i>"GPS Time transfers,"</i> Proc. IEEE, Vol. 79, No. 7, 991-1000
RD06	"SR620 Operating Manual and Programming Reference," Stanford Research Systems

## ACRONYMS

ACRONYMS	
<b>BEV</b>	<b>Bundesamt für Eich- und Vermessungswesen, Wien, Austria</b>
<b>BIPM</b>	<b>Bureau International de Poids et Mesures, Sèvres, France</b>
<b>CGGTTS</b>	<b>CCTF Generic GNSS Time Transfer Standard</b>
<b>DLR IKN</b>	<b>Deutsches Zentrum für Luft- und Raumfahrt, Institut für Kommunikation und Navigation, Oberpfaffenhofen, Germany</b>
<b>EURAMET</b>	<b>The European Association of National Metrology Institutes</b>
<b>IGS</b>	<b>International GNSS Service</b>
<b>GNSS</b>	<b>Global Navigation Satellite System</b>
<b>METAS</b>	<b>Federal Intitue of Metrology, Bern – Wabern, Switzerland</b>
<b>ORB</b>	<b>Observatoire Royal Belgique</b>
<b>PPP</b>	<b>Precise Point Positioning</b>
<b>PTB</b>	<b>Physikalisch-Technische Bundesanstalt, Braunschweig, Germany</b>
<b>RINEX</b>	<b>Receiver Independent Exchange Format</b>
<b>R2CGGTTS</b>	<b>RINEX-to CGGTTS conversion software, provided by ORB / BIPM</b>
<b>TDEV</b>	<b>Time deviation</b>
<b>TIC</b>	<b>Time interval counter</b>
<b>VSL</b>	<b>Dutch Metrology Institute, Delft, The Netherlands</b>

## EXECUTIVE SUMMARY

As part of the support of BIPM Time and Frequency Group by EURAMET, PTB conducted a relative calibration of the GNSS equipment of BEV, DLR IKN, METAS, and VSL with respect to the calibration of PTB receiver PT02, whose last calibration was reported with Cal\_Id=1001-2014 [RD01]. PTB provided its receiver PTBT for the purpose as travelling equipment.

The current campaign followed as much as possible the BIPM Guide [RD02] and results will be reported using Cal\_Id 1012\_2016. Results provided are the visited receivers' internal delays for GPS P-code signals on the two frequencies L1 and L2 (INT DLY (P1), and INT DLY(P2)). Because of the lack of an agreed procedure today, delays for the C/A-code signals on L1 and for GLONASS signals were not determined during this campaign.

The final results are included in Table 12-1. The internal delays of 6 receivers were determined with an uncertainty of about 1 ns for P1 and 0.6 ns for P2, respectively. The uncertainty values for the DLR receivers are larger and influenced by the knowledge of the cable delay of the fixed installation on site. The uncertainty for P3 time transfer links to PTB is of the order 2.1 ns for all sites and all receivers involved if the uncertainty in CAB DLY for the fixed installation is not taken into account.

The calibration campaign suffered from the apparent variability of the internal delays of the travelling receiver, but also of that of the reference receiver PT02. In consequence, the achieved uncertainty values are slightly larger than obtained in previous campaigns.

BIPM suggested minor changes in the uncertainty budget which were introduced in Version 1.1, compared to version 1.0. The BIPM reasoning is based on the observation that this "first" G1G2 calibration report could serve as a kind of template for future reports and should avoid overly optimistic estimates of uncertainty contributions. Details are given in Section 11.

The final values as reported in Table 12-1, rounded to one decimal are not affected and the same as reported in Version 1.0.

As a reminder: All uncertainty values reported in this document are 1- $\sigma$  values.

## 1. CONTENTS OF THE REPORT

As part of the support of BIPM Time and Frequency Group by EURAMET, PTB conducted a relative calibration of the GNSS equipment of BEV, DLR IKN, METAS, and VSL with respect to the calibration of receiver PT02, whose last calibration was reported with Cal\_Id=1001-2014 [RD01]. PTB provided its receiver PTBT for the purpose as travelling equipment. This report documents the installation, data taking and evaluation during the campaign.

The determination of the internal delay values of the receivers at the visited sites is a three-step process.

At first (Common-clock 1, CC1) the travelling receiver, PTBT, is compared to the “golden” receiver, PT02, and the offset between the actual and the assumed PTBT delay values is determined.

After that, the four sites are visited in sequence and the internal delay values of the devices under test, and their statistical properties are determined.

Finally, the stability of the PTBT delay is assessed by a second common-clock measurement (CC2) in PTB. Based thereon, the “final” INT DLY values of the visited receivers and their uncertainty values are calculated.

The structure of this report follows this sequence of work. After presentation of the participants and schedule, a general section follows that contains the (mathematical) calibration procedure, followed by an individual section corresponding to each visited site. The final results and the uncertainty discussion close the report. In the Annex the BIPM information tables are reproduced.



## 2. PARTICIPANTS AND SCHEDULE

Table 2-1: List of participants

Institute	Point of contact	Postal address
PTB	Thomas Polewka Tel +49 531 592 4418 Thomas.polewka@ptb.de	PTB, AG 4.42 Bundesallee 100 38116 Braunschweig, Germany
BEV	Anton Niessner Tel: +43 1 21110 6234 anton.niessner@bev.gv.at	BEV Arltgasse 35 1160 Wien, Austria
DLR IKN	Johann Furthner Tel +49 8153 28 2304 Johann.Furthner@dlr.de	DLR IKN Münchner Straße 20 82234 Weßling, Germany
METAS	Laurent-Guy Bernier +41 58 387 0645 laurent-guy.bernier@metas.ch	METAS Lindenweg 50 CH-3003 Bern-Wabern, Switzerland
VSL	Erik Dierikx Tel +31 15 2691688 edierikx@vsl.nl	VSL Thijsseweg 11 2629 JA Delft, The Netherlands

Table 2-2: Schedule of the campaign

Date	Institute	Action	Remarks
2016-04-04 until 2016-04-10	PTB	First common-clock comparison between PTBT and PT02	7 days used for evaluation, MJD 57482 – 57488 (incl.)
2016-04-19 until 2016-04-24	DLR IKN	Operation of PTBT and five GNSS receivers in parallel	About 5.4 days, MJD 57497 – 57402
2016-05-13 until 2016-05-22	METAS	Operation of PTBT and two GNSS receivers in parallel	8 days used for evaluation, MJD 57522 – 57529 (incl.)
2016-06-02 until 2016-06-07	VSL	Operation of PTBT and two GNSS receivers in parallel	3 days used for evaluation, MJD 57542 – 57544 (incl.)
2016-06-17 until 2016-06-22	BEV	Operation of PTBT and two GNSS receivers in parallel	3 days used for evaluation, MJD 57557 – 57559 (incl.)
Starting 2016-07-04	PTB	Operation of PTBT after return	7 days used for evaluation, MJD 57575 – 57581 (incl.)

Information on the receivers at each site is contained in individual information tables which can be found in the Annex.

### 3. CALIBRATION PROCEDURE

The calculation of INT DLY values for the receiver to be calibrated follows the description given in BIPM TM.212 [RD03] and has been coded in software routine cv.py written by Julia Leute of PTB. The following text piece that describes its function is generated via copy-paste from RD03 with small changes of the designation of quantities.

When dealing with G1G2 calibrations, in principal we distinguish receivers V, T, and G: V for visited, T for travelling, and G for golden\_reference. G1 labs committed to ship their T to the other sites. In the current campaign, PT02 serves as the reference receiver G, its internal delays were determined by BIPM in the first G1 campaign with the identifier Cal\_Id=1001-2014. PTBT served as the travelling receiver T.

Conventionally, the receiver delay D is considered as the sum of different terms that are defined subsequently:

#### (1) INT DLY

The sum  $X_R + X_S$  represents the “INT DLY” field in the CGGTTS header:

$X_R$  represents the receiver hardware delay, between a reference point whose definition depends on the receiver type and the internal time reference of the measurements.  $X_S$  represents the antenna delay, between the phase center and the antenna cable connector at the antenna body. We distinguish the two quantities for the two frequencies, 1 and 2.

INT DLY(P1), and INT DLY(P2) of receiver T are the basic quantities that are determined during the relative calibration. For calculating ionosphere—free observation data, INT DLY(P3) is calculated as  $2.54 \times \text{INT DLY}(P1) - 1.54 \times \text{INT DLY}(P2)$ .

The following terms are considered frequency independent, i. e. no distinction is made for P1 and P2 and other signal frequencies.

#### (2) CAB DLY

The sum  $X_C + X_D$  represents the “CAB DLY” field in the CGGTTS header.

$X_C$  corresponds to the delay of the long cable from the antenna to the input socket at either the antenna splitter or the receiver body directly. If a splitter is installed,  $X_D$  corresponds to the delay of the splitter and small cable up to the receiver body. For a simple set-up with just an antenna cable,  $X_D = 0$ .

#### (3) REF DLY

The sum  $X_P + X_O$  represents the “REF DLY” field in the CGGTTS header.

$X_P$  corresponds to the delay of the cable between the laboratory reference point for local UTC and the 1 PPS-in socket of the receiver.

$X_O$  corresponds to the delay between the 1PPS-in socket and the receiver internal reference point, the latter depending on the receiver type:

- For Ashtech Z12-T: The first positive zero crossing of the inverted 20 MHz-in following the 1PPS-in, delayed by 15.8 ns,

- For Septentrio PolaRx2: The 1PPS-out, delayed by 8.7 ns,
- For Septentrio PolaRx4: The 1 PPS-out, no further correction
- For DICOM GTR50 and GTR51: The 1PPS-in, i.e.  $X_0 = 0$ ,
- For Javad/Topcon: The first positive zero crossing of the 5/10 MHz-in following the 1PPS-in.
- For TTS-4: RD02, Section 2.3.2, and Annex G specify the procedure for TTS-4, which in detail depends on the software version.

Details of the measurement procedures for the Ashtech Z12-T are given in the BIPM calibration guideline [RD02], but the parameters of PT02 were not determined again on occasion of the current campaign.

The distinction of the individual components of the receiver delay reflects the fact that two of them, 2 and 3, can in principle be measured with standard laboratory equipment. Changes of the receiver installation typically affect cabling and thus such delays. The quantity to be determined by the relative calibration is INT DLY: INT DLY of the device under test is determined in such a way that the common-clock differences obtained between the device under test and the reference are zero on average. The INT DLY of T may need to be adjusted so that T and G match, but in practice the small correction needed is taken into account only when INT DLY of V is adjusted to G, using T as intermediate for the measurements made at the different sites.

In the process followed by PTB, valid CGGTTS files with dual frequency observation (L3P) data (including correct, accurate antenna coordinates) are needed. As a reminder,

$$\text{REFGPS}(k) = [\text{REFGPS}_{\text{RAW}} - \text{CAB DLY}_F - \text{INT DLY}(P3) + \text{REF DLY}_F], \quad (1)$$

where REFGPS(k) is reported in column 10 of the standard CGGTTS files, REFGPS<sub>RAW</sub> designates the uncorrected measurement values, INT DLY(P3) is calculated as  $2.54 \times \text{INT DLY}(P1)_F - 1.54 \times \text{INT DLY}(P2)_F$ , and the values  $Q_F$  are reported in the CGGTTS file header.

The software cv.py in calibration mode is used to calculate:

$$\text{REFGPS}_{P1}(j) = \text{REFGPS}(j) + \text{MDIO}(j) \quad (2a)$$

$$\text{REFGPS}_{P2}(j) = \text{REFGPS}(j) + \text{MDIO}(j) + ((f_1/f_2)^2 - 1) \times \text{MSIO}(j), \quad (2b)$$

where  $(f_1/f_2)^2 = 1.647$  for GPS for each satellite observation j and REFGPS(j), MDIO(j), and MSIO(j) are from the line in the CGGTTS file that reports the observation j. Eq. 2a and 2b build on the rules how CGGTTS L3P data lines are generated.

If the common-view condition is fulfilled for the observations with T and G, the differences

$$\Delta P_i = \text{REFGPS}_{P_i}(T) - \text{REFGPS}_{P_i}(G) \quad (3)$$

are calculated. The example here involves G and T, equivalent relations hold for the pair of receivers T and V.

cv.py at the end of the computation edits the median value of all individual observations  $\Delta P_i$  for P1 and P2, and the number of data points used. In addition cv.py generates a file `deltap_stats` that contains observation epoch (MJD.frakt) and the average  $\Delta P_1$ ,  $\Delta P_2$  of all satellite observations at that epoch. Such values are plotted throughout the report in the various figures.

The calculation of the INT DLY values comprises two steps:

$$\text{Step 1: INT DLY}(P_i)_T_{\text{corr}} = \Delta P_i(T,G) + \text{INT DLY}(P_i)_T_{\text{F}}, \quad (4)$$

where the last summand  $>_F <$  is the value reported in the CGGTTS file.

Step 2: The final results for receiver V is to be calculated as

$$\text{INT DLY}(P_i)_V_{\text{new}} = \Delta P_i(V,T) + \langle \Delta P_i(T,G) \rangle + \text{INT DLY}(P_i)_V_{\text{F}}, \quad (5)$$

where  $\langle \Delta P_i(T,G) \rangle$  is the mean value obtained during CC1 and CC2. Another option would have been to adjust the INT DLY of receiver T after CC1, but this was not done.

The third summand in (5) on the right represents the INT DLY value that was reported previously in the CGGTTS file of receiver V. In many cases this value was zero (as in case of the DLR receivers, as example).

## 4. CHARACTERIZATION OF PTB EQUIPMENT

The receiver PTBT was functionally tested before shipment to the first visited institute, DLR IKN. Figure 4-1 shows the result of long-term common-clock common-view comparisons between PTBT, PT03, and PT02. PT03 is a receiver of the same kind as PT02. The PTBT– PT02 data are split into two groups. At MJD 57461 the antenna cable of PTBT was changed from a shorter 50-m cable to the 65-m cable which has been used throughout the current campaign. The CAB DLY was corrected using the respective measured values. The difference between the mean of the two data sets is 0.65 ns which is compatible with the uncertainty for time interval measurement of the time interval counter of type SR620. The two CAB DLY values were measured 2012 and 2016, respectively, and no record is kept which counter was used in 2012. For the current campaign, the same antenna cable and the same CAB DLY value is used in all PTBT files. Even if this value is incorrect, the result of the relative calibration of the internal delays of the receivers at the visited sites is not affected. The long-term stability of the PTBT is further discussed in Section 10.

The installation of the receivers in PTB is depicted in Figure 4-2 for 1 PPS signals and in Figure 4-3 for 5 MHz signals. The PT02 and PT03 receivers are supplied with 20 MHz from a times 4 multiplier.

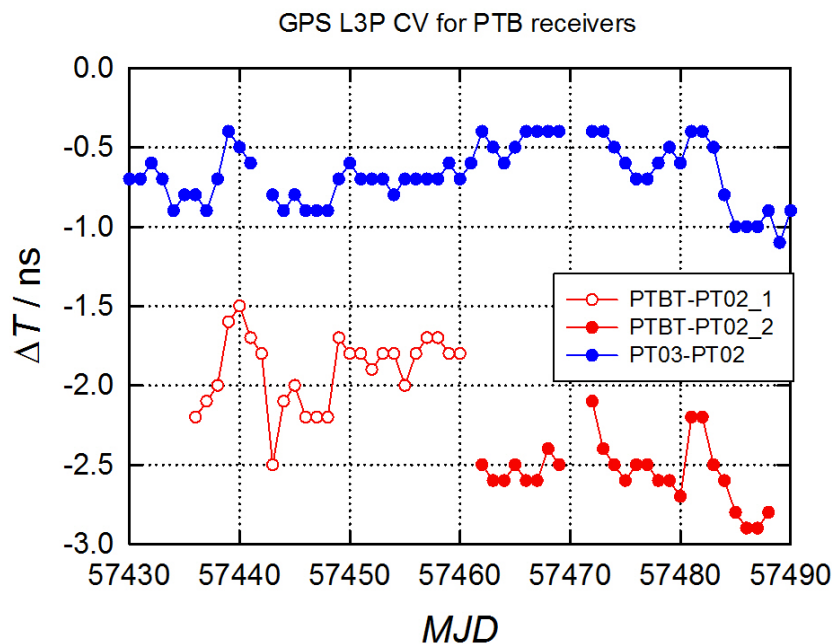

Figure 4-1: Common-clock common-view comparison between GPS receivers at PTB, daily mean values

We note from Figure 4-1 that PTBT and PT02 are indeed not perfectly aligned. The correct PTBT INT DLY( $P_i$ ) values to be used in the calculation of INT DLY of receivers  $V$  is determined using eq. (5) as explained before.

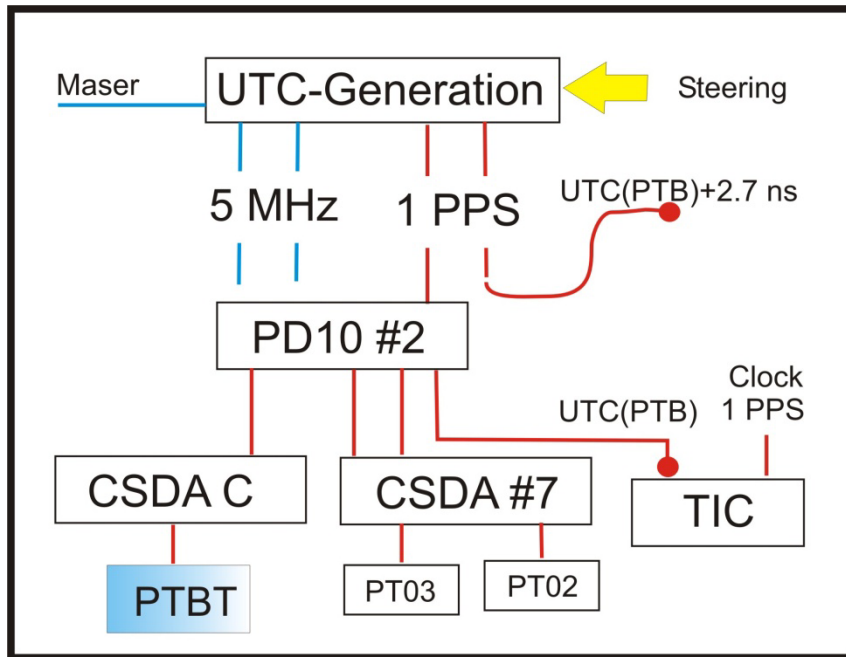

Figure 4-2: UTC(PTB) reference point and 1 PPS signal distribution to PT02, PT03 and PTBT

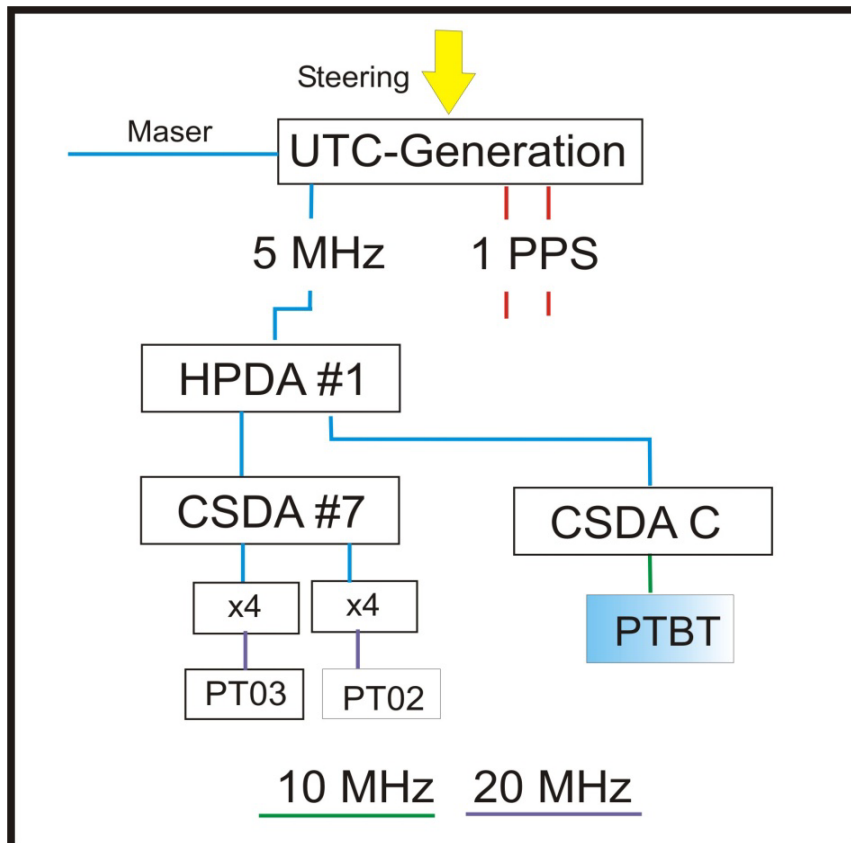

Figure 4-3: UTC(PTB) signal distribution (5 MHz, 10 MHz, 20 MHz) to PT02, PT03 and PTBT



**Figure 4-4: Installation of GNSS antennas at PTB**

Figure 4-4 illustrates the installation of GNSS antennas on the roof of the PTB time laboratory (clock hall). The two Ashtech SNOW antennas (with dome) belong to PT03 (background) and PT02 (middle). The PTBT antenna was mounted on the mast in the forefront, replacing the choke-ring antenna that was mounted at the time when the picture was taken.



## 5. RESULTS OF COMMON-CLOCK SET-UP IN PTB: PERIOD 1

The period 57482 to 57488 (7 days, 2016-04-10 – 2016-04 16) was chosen to determine the initial PTBT INT DLY values (CC1). The result of comparison with PT02 as the reference are shown in Figure 5-1 illustrating in total 622  $\Delta P_i$  (see eq. 3) values obtained as mean over all common view observations at a given epoch. The time instability (TDEV) plots for the two data sets follow as Figure 5-2. In addition to the measurement noise, there is a small variation in the  $\Delta P_1$  values which is absent in the  $\Delta P_2$  values. This is reflected in the two TDEV plots. The numerical results are given in the Summary sub-section at the end of the report on CC2 in PTB.

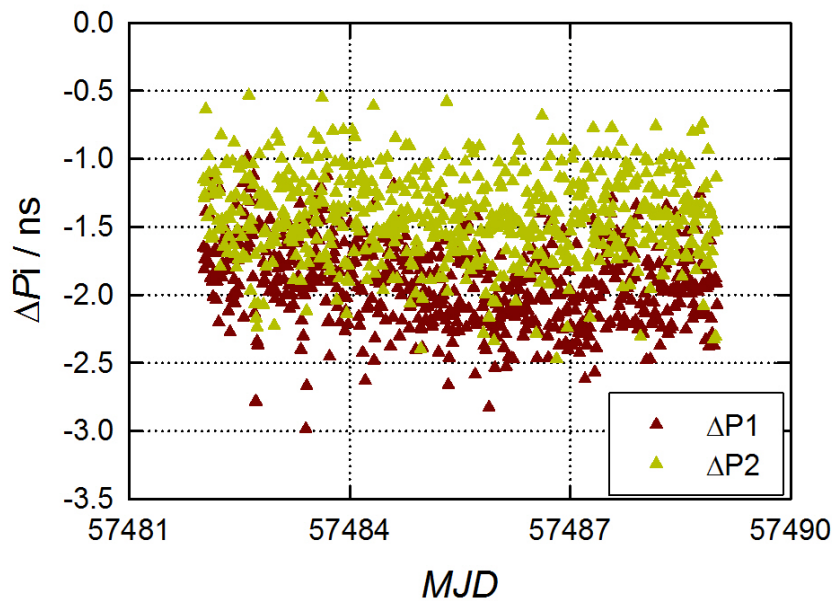

Figure 5-1:  $\Delta P_i$  values obtained during the first common-clock set-up in PTB.

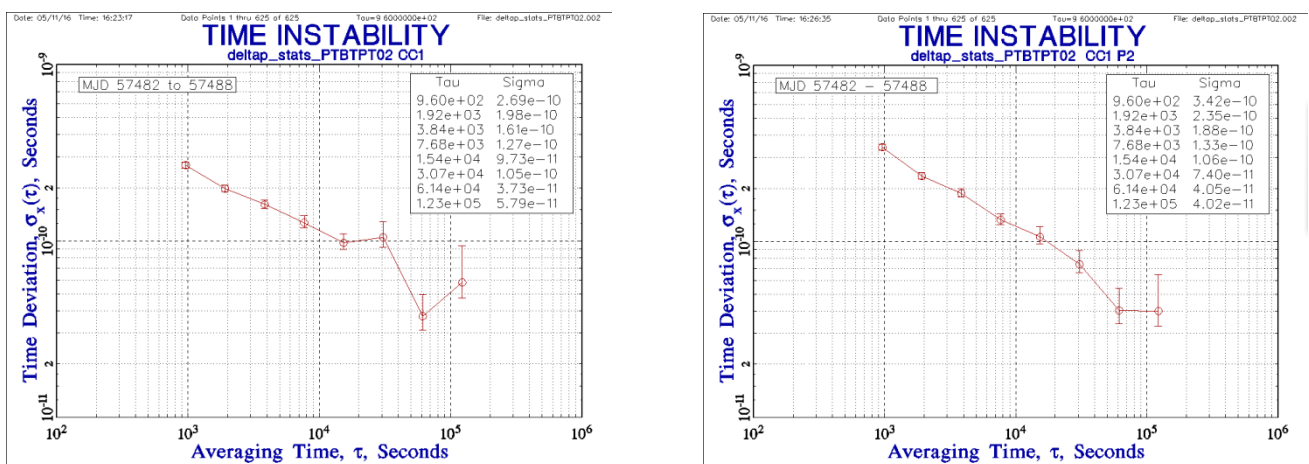

Figure 5-2: TDEV obtained for the two data sets shown in,  $\Delta P_1$  left,  $\Delta P_2$  right.

The INT DLY( $P_i$ ) of PTBT have not been corrected for the offsets shown in Figure 5-1 before shipment. Instead, the individual value found for the visited receivers will be corrected for the mean value obtained after the second common-clock set-up (see eq. 5)).

## 6. OPERATION OF PTBT IN DLR

PTBT was operated at DLR IKN for about 5.5 days between MJD 57497 and 57503 (2016-04-19 – 2016-04-24). In parallel, 5 GNSS receivers were operated, all made by Septentrio, but coming in different versions. Their designations are UTC1, UTC2, UTC3, UTC4, and OBET. Details on the receivers and their installation are given in the Annex. The antenna coordinates were determined in current ITRF shortly before the campaign for both masts in use.

The installation of the receivers in the DLR IKN time laboratory is illustrated in Figure 6-1 in which the receiver OBET is designated as UTC5. The mounting of the PTBT antenna is shown in Figure 6-2. The Septentrio receivers primarily generate RINEX 2.1 files, and conversion to CGGTTS files was either done via the software installed on the receivers or externally. It turned out that some of the files were corrupted on individual days.

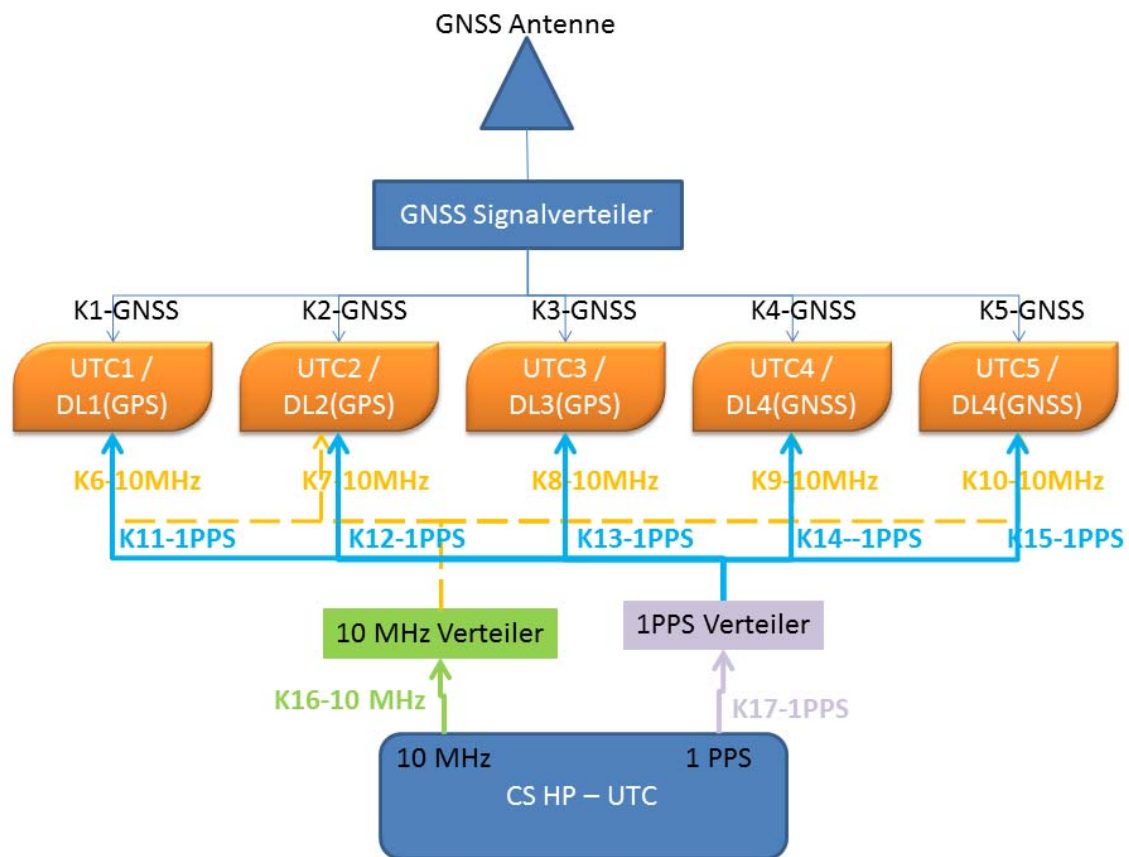

Figure 6-1: Scheme of the installation of the GNSS receivers at DLR IKN



Figure 6-2: Installation of the PTBT antenna on the DLR IKN antenna rack

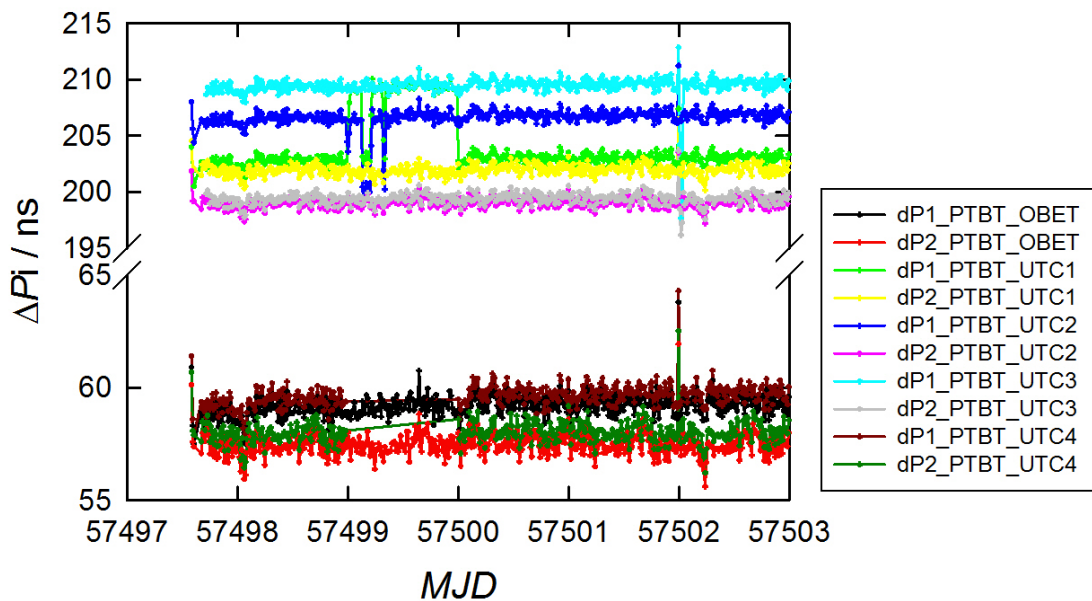

Figure 6-3:  $\Delta P_i$ -values recorded between PTBT and 5 GNSS receivers at DLR IKN.

In Figure 6-3, the  $\Delta P_i$  (3) derived from the raw data are depicted. The data from UTC1 and UTC4 on day 57499 were discarded as the  $\Delta P_i$  jumped between discrete values for several hours. Further individual outliers were removed from the data of all receivers, so that finally cleaned data were used to calculate the  $\Delta P_i$ , as shown in Figure 6-4.

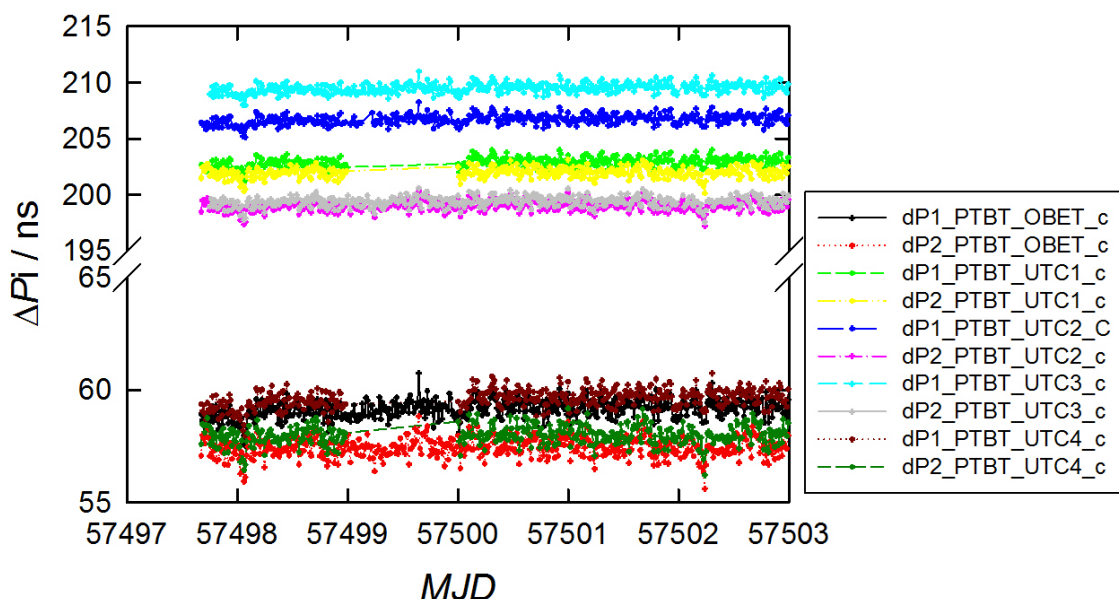

Figure 6-4:  $\Delta P_i$ -values recorded between PTBT and 5 GNSS receivers at DLR IKN, outliers and corrupted data removed

Table 6-1:  $\Delta INT DLY(P_i)$  values and statistical properties obtained initially.

$\Delta INT DLY(P_i)$ for receivers at DLR IKN	Mean / ns	Median / ns	Std.Dev. / ns	TDEV / ns	Number of epochs
OBET P1	59.14	59.15	0.40	0.10	474
OBET P2	57.42	57.41	0.42	0.15	474
UTC1 P1	202.89	202.92	0.42	0.10	386
UTC1 P2	201.98	202.02	0.44	0.15	386
UTC2 P1	206.71	206.71	0.42	0.10	462
UTC2 P2	199.04	199.07	0.43	0.15	462
UTC3 P1	209.49	209.50	0.42	0.10	465
UTC3 P2	199.39	199.43	0.43	0.15	465
UTC4 P1	59.62	59.64	0.43	0.10	385
UTC4 P2	57.99	57.98	0.43	0.15	385

In Table 6-1 the results obtained for the  $\Delta INT DLY(P_i)$  values with respect to the initial PTBT values and their statistical uncertainty are collected. The corresponding TDEV plots are shown in Table 6-2. As a statistical measurement uncertainty the value of TDEV at  $\tau$  equal to about one tenth of the total measurement time (about 30 000 s) is chosen, cum grano salis to be not too optimistic. The corresponding TDEV plots are collected in Table 6-2.

This practice has been followed for the data collected at all sites.

Table 6-2: Time instability of the  $\Delta P_1$ -values obtained for the five GNSS receivers at DLR IKN with reference to receiver PTBT

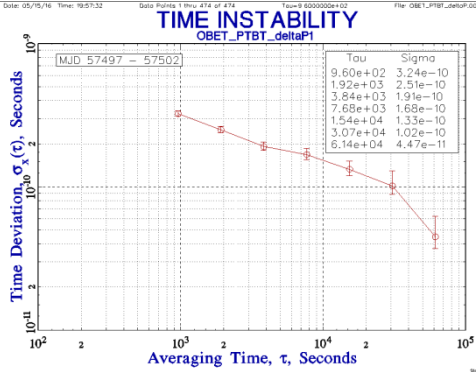
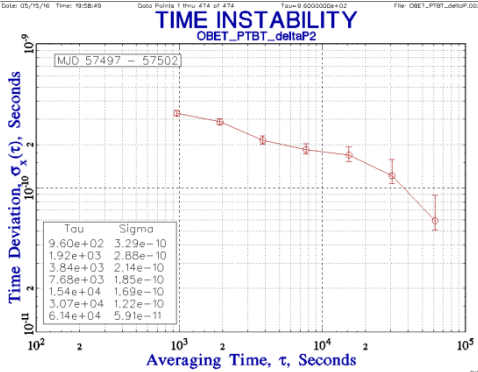
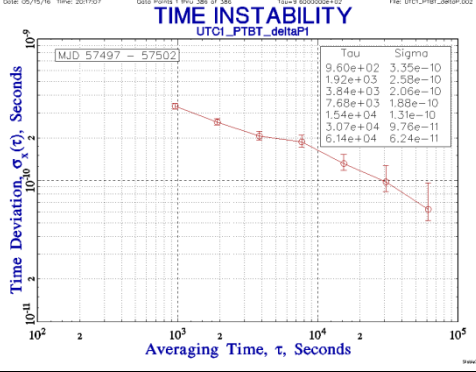
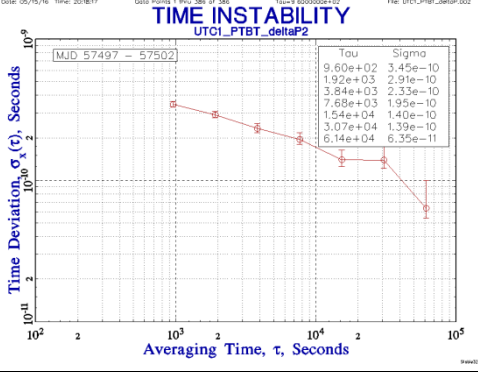
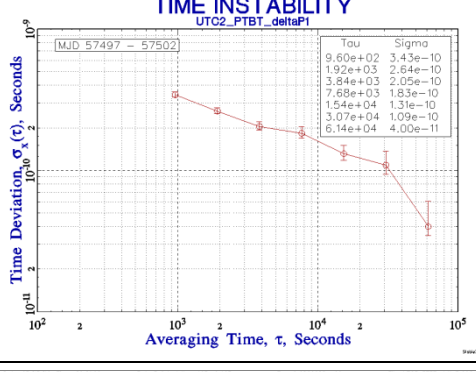
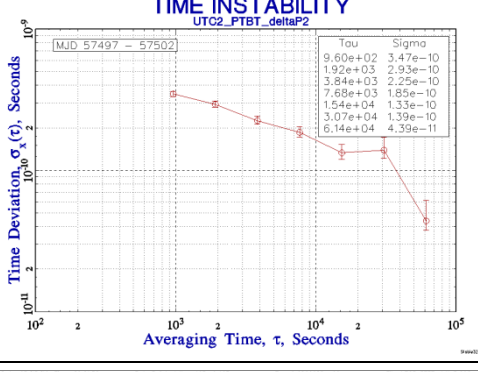
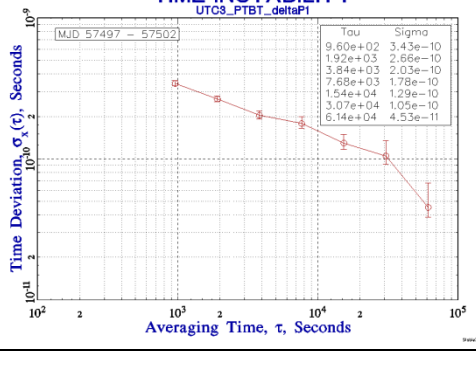
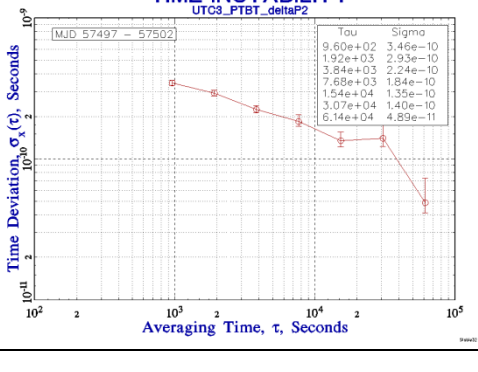
Receiver at DLR IKN	Time instability of $\Delta P_1$ -values	Time instability of $\Delta P_2$ -values																																
OBET	 <table border="1"> <thead> <tr> <th>Tau</th> <th>Sigma</th> </tr> </thead> <tbody> <tr><td>9.60e+02</td><td>3.24e-10</td></tr> <tr><td>1.92e+03</td><td>2.51e-10</td></tr> <tr><td>3.84e+03</td><td>1.91e-10</td></tr> <tr><td>7.68e+03</td><td>1.68e-10</td></tr> <tr><td>1.54e+04</td><td>1.33e-10</td></tr> <tr><td>3.07e+04</td><td>1.02e-10</td></tr> <tr><td>6.14e+04</td><td>4.47e-11</td></tr> </tbody> </table>	Tau	Sigma	9.60e+02	3.24e-10	1.92e+03	2.51e-10	3.84e+03	1.91e-10	7.68e+03	1.68e-10	1.54e+04	1.33e-10	3.07e+04	1.02e-10	6.14e+04	4.47e-11	 <table border="1"> <thead> <tr> <th>Tau</th> <th>Sigma</th> </tr> </thead> <tbody> <tr><td>9.60e+02</td><td>3.29e-10</td></tr> <tr><td>1.92e+03</td><td>2.86e-10</td></tr> <tr><td>3.84e+03</td><td>2.14e-10</td></tr> <tr><td>7.68e+03</td><td>1.85e-10</td></tr> <tr><td>1.54e+04</td><td>1.69e-10</td></tr> <tr><td>3.07e+04</td><td>1.22e-10</td></tr> <tr><td>6.14e+04</td><td>5.91e-11</td></tr> </tbody> </table>	Tau	Sigma	9.60e+02	3.29e-10	1.92e+03	2.86e-10	3.84e+03	2.14e-10	7.68e+03	1.85e-10	1.54e+04	1.69e-10	3.07e+04	1.22e-10	6.14e+04	5.91e-11
Tau	Sigma																																	
9.60e+02	3.24e-10																																	
1.92e+03	2.51e-10																																	
3.84e+03	1.91e-10																																	
7.68e+03	1.68e-10																																	
1.54e+04	1.33e-10																																	
3.07e+04	1.02e-10																																	
6.14e+04	4.47e-11																																	
Tau	Sigma																																	
9.60e+02	3.29e-10																																	
1.92e+03	2.86e-10																																	
3.84e+03	2.14e-10																																	
7.68e+03	1.85e-10																																	
1.54e+04	1.69e-10																																	
3.07e+04	1.22e-10																																	
6.14e+04	5.91e-11																																	
UTC1	 <table border="1"> <thead> <tr> <th>Tau</th> <th>Sigma</th> </tr> </thead> <tbody> <tr><td>9.60e+02</td><td>3.35e-10</td></tr> <tr><td>1.92e+03</td><td>2.58e-10</td></tr> <tr><td>3.84e+03</td><td>2.05e-10</td></tr> <tr><td>7.68e+03</td><td>1.85e-10</td></tr> <tr><td>1.54e+04</td><td>1.31e-10</td></tr> <tr><td>3.07e+04</td><td>9.76e-11</td></tr> <tr><td>6.14e+04</td><td>6.24e-11</td></tr> </tbody> </table>	Tau	Sigma	9.60e+02	3.35e-10	1.92e+03	2.58e-10	3.84e+03	2.05e-10	7.68e+03	1.85e-10	1.54e+04	1.31e-10	3.07e+04	9.76e-11	6.14e+04	6.24e-11	 <table border="1"> <thead> <tr> <th>Tau</th> <th>Sigma</th> </tr> </thead> <tbody> <tr><td>9.60e+02</td><td>3.45e-10</td></tr> <tr><td>1.92e+03</td><td>2.91e-10</td></tr> <tr><td>3.84e+03</td><td>2.33e-10</td></tr> <tr><td>7.68e+03</td><td>1.95e-10</td></tr> <tr><td>1.54e+04</td><td>1.40e-10</td></tr> <tr><td>3.07e+04</td><td>1.39e-10</td></tr> <tr><td>6.14e+04</td><td>6.35e-11</td></tr> </tbody> </table>	Tau	Sigma	9.60e+02	3.45e-10	1.92e+03	2.91e-10	3.84e+03	2.33e-10	7.68e+03	1.95e-10	1.54e+04	1.40e-10	3.07e+04	1.39e-10	6.14e+04	6.35e-11
Tau	Sigma																																	
9.60e+02	3.35e-10																																	
1.92e+03	2.58e-10																																	
3.84e+03	2.05e-10																																	
7.68e+03	1.85e-10																																	
1.54e+04	1.31e-10																																	
3.07e+04	9.76e-11																																	
6.14e+04	6.24e-11																																	
Tau	Sigma																																	
9.60e+02	3.45e-10																																	
1.92e+03	2.91e-10																																	
3.84e+03	2.33e-10																																	
7.68e+03	1.95e-10																																	
1.54e+04	1.40e-10																																	
3.07e+04	1.39e-10																																	
6.14e+04	6.35e-11																																	
UTC2	 <table border="1"> <thead> <tr> <th>Tau</th> <th>Sigma</th> </tr> </thead> <tbody> <tr><td>9.60e+02</td><td>3.43e-10</td></tr> <tr><td>1.92e+03</td><td>2.64e-10</td></tr> <tr><td>3.84e+03</td><td>2.05e-10</td></tr> <tr><td>7.68e+03</td><td>1.83e-10</td></tr> <tr><td>1.54e+04</td><td>1.31e-10</td></tr> <tr><td>3.07e+04</td><td>1.09e-10</td></tr> <tr><td>6.14e+04</td><td>4.00e-11</td></tr> </tbody> </table>	Tau	Sigma	9.60e+02	3.43e-10	1.92e+03	2.64e-10	3.84e+03	2.05e-10	7.68e+03	1.83e-10	1.54e+04	1.31e-10	3.07e+04	1.09e-10	6.14e+04	4.00e-11	 <table border="1"> <thead> <tr> <th>Tau</th> <th>Sigma</th> </tr> </thead> <tbody> <tr><td>9.60e+02</td><td>3.47e-10</td></tr> <tr><td>1.92e+03</td><td>2.93e-10</td></tr> <tr><td>3.84e+03</td><td>2.25e-10</td></tr> <tr><td>7.68e+03</td><td>1.85e-10</td></tr> <tr><td>1.54e+04</td><td>1.33e-10</td></tr> <tr><td>3.07e+04</td><td>1.39e-10</td></tr> <tr><td>6.14e+04</td><td>4.39e-11</td></tr> </tbody> </table>	Tau	Sigma	9.60e+02	3.47e-10	1.92e+03	2.93e-10	3.84e+03	2.25e-10	7.68e+03	1.85e-10	1.54e+04	1.33e-10	3.07e+04	1.39e-10	6.14e+04	4.39e-11
Tau	Sigma																																	
9.60e+02	3.43e-10																																	
1.92e+03	2.64e-10																																	
3.84e+03	2.05e-10																																	
7.68e+03	1.83e-10																																	
1.54e+04	1.31e-10																																	
3.07e+04	1.09e-10																																	
6.14e+04	4.00e-11																																	
Tau	Sigma																																	
9.60e+02	3.47e-10																																	
1.92e+03	2.93e-10																																	
3.84e+03	2.25e-10																																	
7.68e+03	1.85e-10																																	
1.54e+04	1.33e-10																																	
3.07e+04	1.39e-10																																	
6.14e+04	4.39e-11																																	
UTC3	 <table border="1"> <thead> <tr> <th>Tau</th> <th>Sigma</th> </tr> </thead> <tbody> <tr><td>9.60e+02</td><td>3.43e-10</td></tr> <tr><td>1.92e+03</td><td>2.66e-10</td></tr> <tr><td>3.84e+03</td><td>2.03e-10</td></tr> <tr><td>7.68e+03</td><td>1.78e-10</td></tr> <tr><td>1.54e+04</td><td>1.29e-10</td></tr> <tr><td>3.07e+04</td><td>1.05e-10</td></tr> <tr><td>6.14e+04</td><td>4.53e-11</td></tr> </tbody> </table>	Tau	Sigma	9.60e+02	3.43e-10	1.92e+03	2.66e-10	3.84e+03	2.03e-10	7.68e+03	1.78e-10	1.54e+04	1.29e-10	3.07e+04	1.05e-10	6.14e+04	4.53e-11	 <table border="1"> <thead> <tr> <th>Tau</th> <th>Sigma</th> </tr> </thead> <tbody> <tr><td>9.60e+02</td><td>3.46e-10</td></tr> <tr><td>1.92e+03</td><td>2.93e-10</td></tr> <tr><td>3.84e+03</td><td>2.24e-10</td></tr> <tr><td>7.68e+03</td><td>1.84e-10</td></tr> <tr><td>1.54e+04</td><td>1.35e-10</td></tr> <tr><td>3.07e+04</td><td>1.40e-10</td></tr> <tr><td>6.14e+04</td><td>4.89e-11</td></tr> </tbody> </table>	Tau	Sigma	9.60e+02	3.46e-10	1.92e+03	2.93e-10	3.84e+03	2.24e-10	7.68e+03	1.84e-10	1.54e+04	1.35e-10	3.07e+04	1.40e-10	6.14e+04	4.89e-11
Tau	Sigma																																	
9.60e+02	3.43e-10																																	
1.92e+03	2.66e-10																																	
3.84e+03	2.03e-10																																	
7.68e+03	1.78e-10																																	
1.54e+04	1.29e-10																																	
3.07e+04	1.05e-10																																	
6.14e+04	4.53e-11																																	
Tau	Sigma																																	
9.60e+02	3.46e-10																																	
1.92e+03	2.93e-10																																	
3.84e+03	2.24e-10																																	
7.68e+03	1.84e-10																																	
1.54e+04	1.35e-10																																	
3.07e+04	1.40e-10																																	
6.14e+04	4.89e-11																																	

UTC4

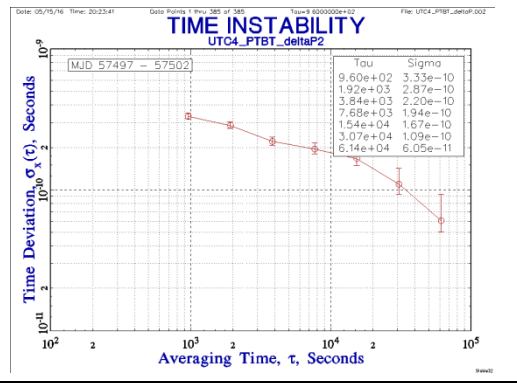
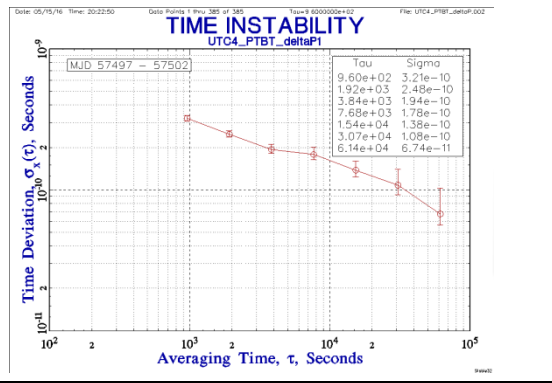

## 7. OPERATION OF PTBT AT METAS

PTBT was operated at METAS for almost 8 days, and the seven completely covered days MJD 57522 to MJD 57529 (2016-05-14 – 2016-05-21) were used for the evaluation. In parallel, 2 METAS GNSS receivers were operated, with designations CH00 and CH01. Details on the receivers and their installation are given in the Annex. The installation of the receivers in the METAS time laboratory is illustrated in Figure 7-1. The mounting of GNSS antennas at METAS is shown in Figure 7-2. Here we see the antennas of CH00 and CH01 on the right. On the left one can see the WAB3 location with an Ashtech antenna which is no longer used. The PTBT antenna was mounted on the WAB3 location. The empty mounting structure without an antenna is reserved for WAB4. The mounting structures represent the standard mounting structures used by Swiss Topo and the geodetic community in Switzerland. The mounting structure has a flat top which defines the antenna mounting plane. So it is designed for an antenna which has the RF connector on the side and the cable leaving horizontally. The PTBT antenna thus needed to be mounted on an extender (compare Figure 6-2).

The CGGTTS files were generated from RINEX 2.1 files using R2CGGTTS v5.1 for CH00 and R2CGGTTS v4.3 for receiver CH01. Antenna coordinates had been newly determined consistently by METAS.

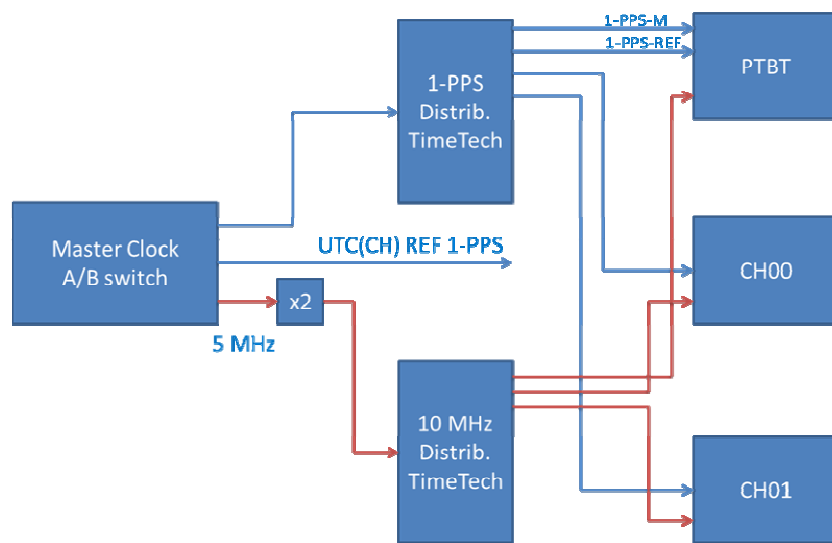

Figure 7-1: Scheme of the installation of the GNSS receivers at METAS



Figure 7-2: Installation of GNSS antennas on the METAS roof

The data were of very good quality, a single data point was removed as outlier that occurred at the day boundary 57023.0. The data used are depicted in Figure 7-3

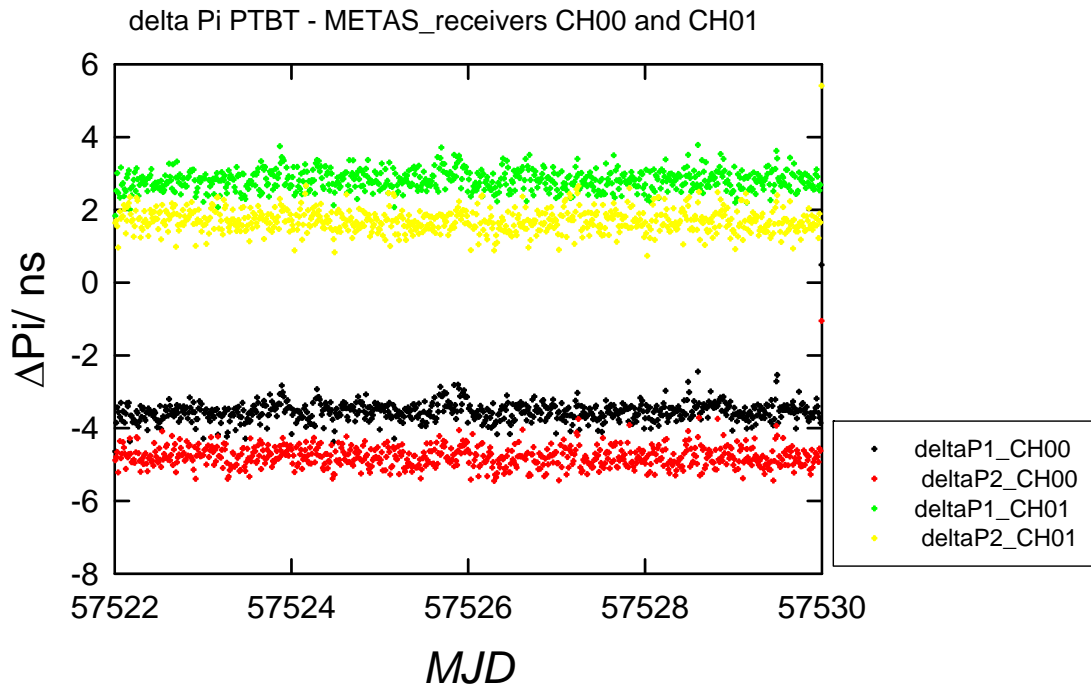

Figure 7-3:  $\Delta Pi$ -values recorded between PTBT and 2 GNSS receivers at METAS, one outlier removed

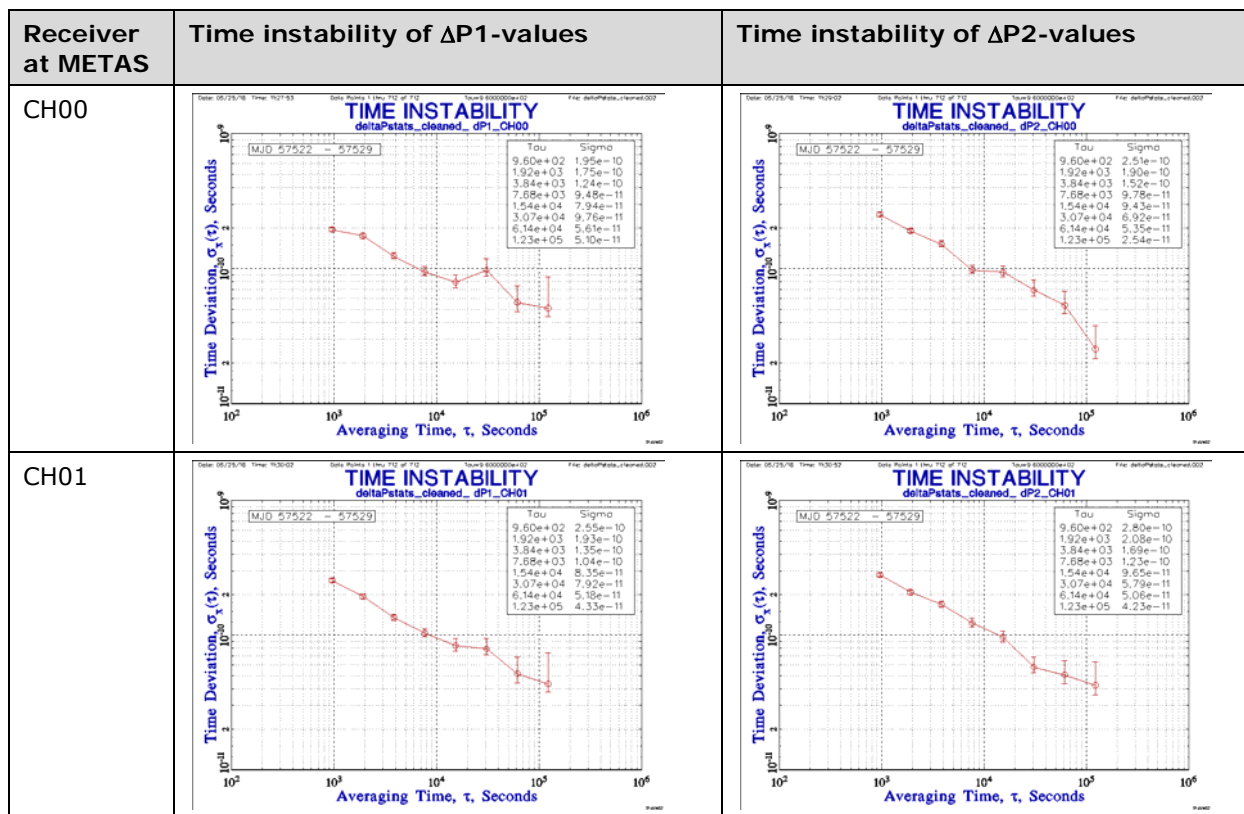

Table 7-1:  $\Delta$ INT DLY( $P_i$ ) values and statistical properties obtained initially. TDEV values are estimates based on the graphs shown in Table 7-2.

$\Delta$ INT DLY( $P_i$ ) for receivers at METAS	Mean / ns	Median / ns	Std.Dev. / ns	TDEV / ns	Number of epochs
CH00 P1	-3.54	-3.54	0.29	0.1	712
CH00 P2	-4.78	-4.79	0.31	0.1	712
CH01 P1	2.82	2.81	0.31	0.1	712
CH01 P2	1.70	1.69	0.33	0.1	713

In Table 7-1 the results obtained for the  $\Delta$ INT DLY( $P_i$ ) values with respect to the initial PTBT values and their statistical uncertainty are collected. The corresponding TDEV plots are shown in Table 7-2.

Table 7-2: Time instability of the  $\Delta P_i$ -values obtained for the two GNSS receivers at METAS with reference to receiver PTBT



## 8. OPERATION OF PTBT AT VSL

PTBT was operated at VSL for about 5 days. In parallel, 2 VSL GNSS receivers were operated, with designations VSLF and VSLG (file names GZVS06.. and GZVS07..). Details on the receivers and their installation are given in the Annex. The installation of the receivers in the VSL time laboratory is illustrated in Figure 8-1. The mounting of GNSS antennas at VSL is shown in Figure 8-2. The PTBT antenna needed to be mounted on an extender, similar as in METAS.

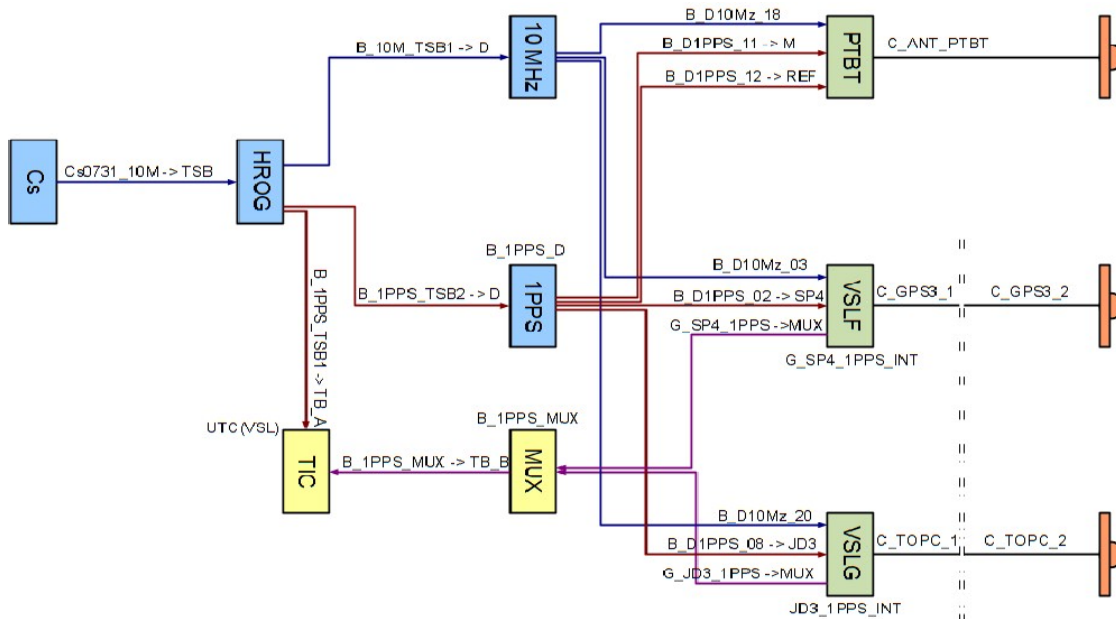

Figure 8-1: Scheme of the installation of the GNSS receivers at VSL



Figure 8-2: Installation of GNSS antennas on the VSL roof: from left to right: VSLG, VSLF, and PTBT

The coordinates of the PTBT antenna post were initially estimated by VSL based on a previous campaign, and the coordinates were used to produce the PTBT CGGTTS files for the days in question. Later VSL determined the PTBT antenna coordinates by processing PTBT RINEX 2.1 files with the NRCAN PPP software package [RD04]. The differences exceeded 15 cm for the X-coordinate and about 10 cm for the other coordinates. Therefore new CGGTTS files with the

new coordinates were generated using r2cggts V. 5.1. As this process requires RINEX files of days  $k$  and  $k+1$  for the generation of the CGGTTS file of day  $k$ , in the end only three days of data (MJD 57542 to MJD 57544 (2016-06-04 – 2016-06-06) were available for the determination of the  $\Delta$ INT DLY ( $P_i$ ) for the two VSL receivers. With this approach, all coordinates used were generated in a consistent way using the same procedure within a few weeks. The data used are depicted in Figure 8-3. In Table 8-1 the results obtained for the  $\Delta$ INT DLY( $P_i$ ) values obtained with respect to the initial PTBT values and their statistical uncertainty are collected. The TDEV plots are shown in Table 8-2. The large  $\Delta P_i$  values for VSLF can be explained by the fact that the delay values used in VSLF had been previously aligned to another calibrated receiver without proper distinction of the P1 and P2 delays.

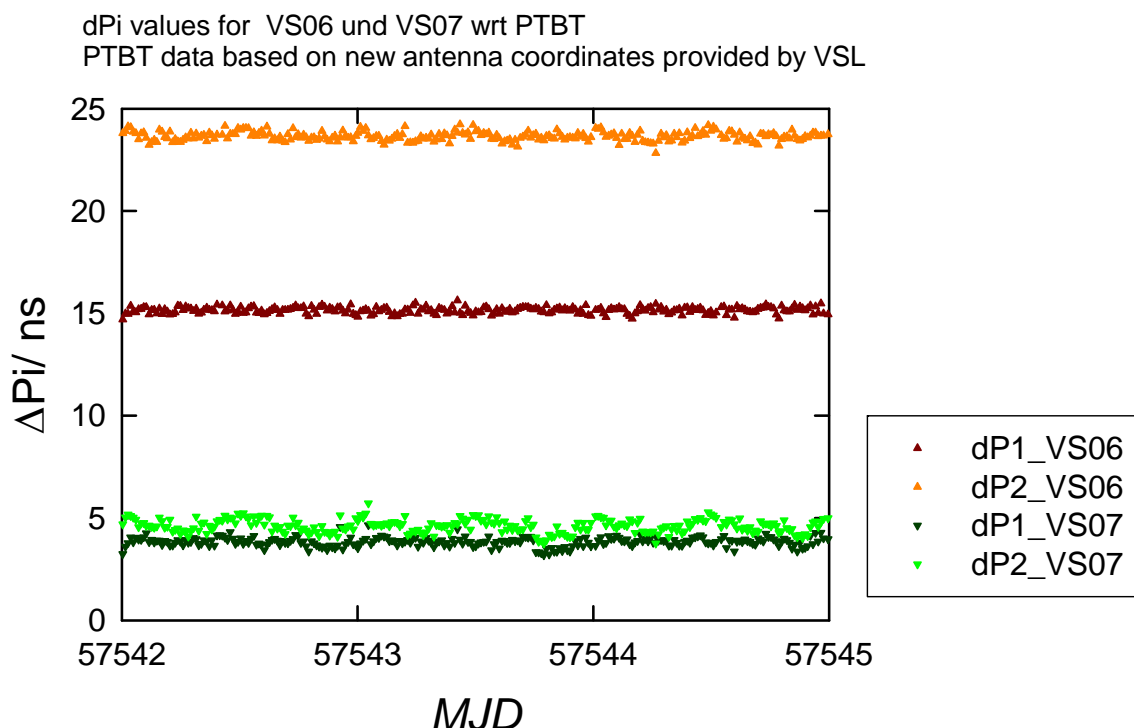
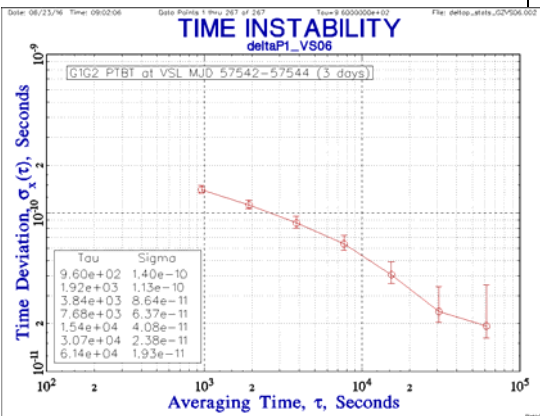
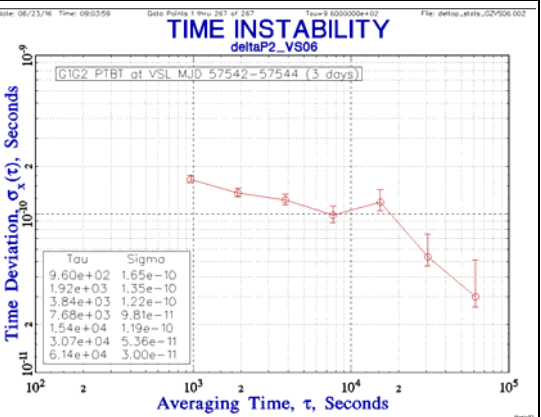
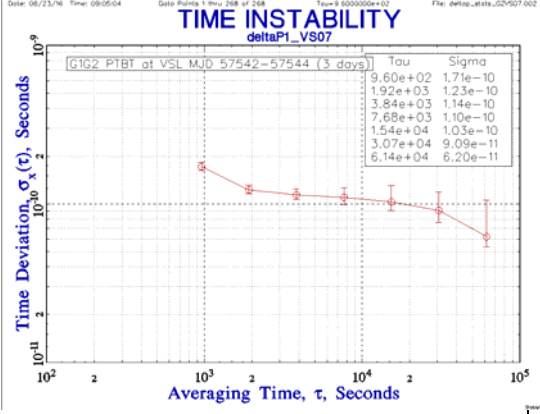
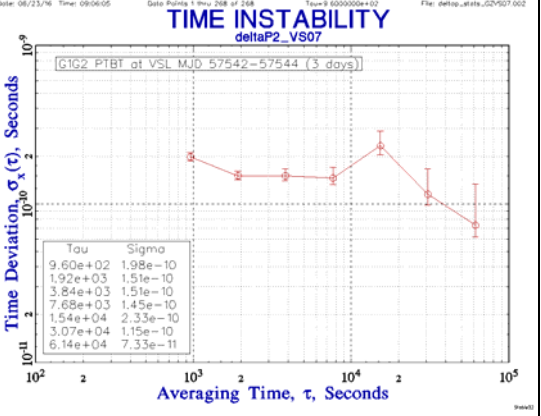

Figure 8-3:  $\Delta P_i$ -values recorded between PTBT and 2 GNSS receivers at VSL

Table 8-1:  $\Delta$ INT DLY( $P_i$ ) values and statistical properties obtained initially. TDEV values are estimates based on the graphs shown in Figure 8-3.

$\Delta$ INT DLY( $P_i$ ) for receivers at VSL	Mean / ns	Median / ns	Std.Dev. / ns	TDEV / ns	Number of epochs
VSL06 P1	15.15	15.17	0.16	0.05	267
VSL06 P2	23.65	23.65	0.22	0.1	267
VSL07 P1	3.83	3.85	0.22	0.1	268
VSL07 P2	4.62	4.62	0.32	0.15	268

Table 8-2: Time instability of the  $\Delta P1$ -values obtained for the two GNSS receivers at VSL with reference to receiver PTBT

Receiver at VSL	Time instability of $\Delta P1$ -values	Time instability of $\Delta P2$ -values																																
VSL06	 <p><b>TIME INSTABILITY</b> deltaP1_VS06</p> <p>GIG2 PTBT at VSL MJD 57542-57544 (3 days)</p> <table border="1"> <thead> <tr> <th>Tau</th> <th>Sigma</th> </tr> </thead> <tbody> <tr><td>9.60e+02</td><td>1.40e-10</td></tr> <tr><td>1.92e+03</td><td>1.13e-10</td></tr> <tr><td>3.84e+03</td><td>8.64e-11</td></tr> <tr><td>7.68e+03</td><td>6.37e-11</td></tr> <tr><td>1.54e+04</td><td>4.08e-11</td></tr> <tr><td>3.07e+04</td><td>2.38e-11</td></tr> <tr><td>6.14e+04</td><td>1.93e-11</td></tr> </tbody> </table>	Tau	Sigma	9.60e+02	1.40e-10	1.92e+03	1.13e-10	3.84e+03	8.64e-11	7.68e+03	6.37e-11	1.54e+04	4.08e-11	3.07e+04	2.38e-11	6.14e+04	1.93e-11	 <p><b>TIME INSTABILITY</b> deltaP2_VS06</p> <p>GIG2 PTBT at VSL MJD 57542-57544 (3 days)</p> <table border="1"> <thead> <tr> <th>Tau</th> <th>Sigma</th> </tr> </thead> <tbody> <tr><td>9.60e+02</td><td>1.65e-10</td></tr> <tr><td>1.92e+03</td><td>1.35e-10</td></tr> <tr><td>3.84e+03</td><td>1.22e-10</td></tr> <tr><td>7.68e+03</td><td>9.81e-11</td></tr> <tr><td>1.54e+04</td><td>1.19e-10</td></tr> <tr><td>3.07e+04</td><td>5.36e-11</td></tr> <tr><td>6.14e+04</td><td>3.00e-11</td></tr> </tbody> </table>	Tau	Sigma	9.60e+02	1.65e-10	1.92e+03	1.35e-10	3.84e+03	1.22e-10	7.68e+03	9.81e-11	1.54e+04	1.19e-10	3.07e+04	5.36e-11	6.14e+04	3.00e-11
Tau	Sigma																																	
9.60e+02	1.40e-10																																	
1.92e+03	1.13e-10																																	
3.84e+03	8.64e-11																																	
7.68e+03	6.37e-11																																	
1.54e+04	4.08e-11																																	
3.07e+04	2.38e-11																																	
6.14e+04	1.93e-11																																	
Tau	Sigma																																	
9.60e+02	1.65e-10																																	
1.92e+03	1.35e-10																																	
3.84e+03	1.22e-10																																	
7.68e+03	9.81e-11																																	
1.54e+04	1.19e-10																																	
3.07e+04	5.36e-11																																	
6.14e+04	3.00e-11																																	
VSL07	 <p><b>TIME INSTABILITY</b> deltaP1_VS07</p> <p>GIG2 PTBT at VSL MJD 57542-57544 (3 days)</p> <table border="1"> <thead> <tr> <th>Tau</th> <th>Sigma</th> </tr> </thead> <tbody> <tr><td>9.60e+02</td><td>1.71e-10</td></tr> <tr><td>1.92e+03</td><td>1.23e-10</td></tr> <tr><td>3.84e+03</td><td>1.14e-10</td></tr> <tr><td>7.68e+03</td><td>1.10e-10</td></tr> <tr><td>1.54e+04</td><td>1.03e-10</td></tr> <tr><td>3.07e+04</td><td>9.09e-11</td></tr> <tr><td>6.14e+04</td><td>6.20e-11</td></tr> </tbody> </table>	Tau	Sigma	9.60e+02	1.71e-10	1.92e+03	1.23e-10	3.84e+03	1.14e-10	7.68e+03	1.10e-10	1.54e+04	1.03e-10	3.07e+04	9.09e-11	6.14e+04	6.20e-11	 <p><b>TIME INSTABILITY</b> deltaP2_VS07</p> <p>GIG2 PTBT at VSL MJD 57542-57544 (3 days)</p> <table border="1"> <thead> <tr> <th>Tau</th> <th>Sigma</th> </tr> </thead> <tbody> <tr><td>9.60e+02</td><td>1.98e-10</td></tr> <tr><td>1.92e+03</td><td>1.51e-10</td></tr> <tr><td>3.84e+03</td><td>1.51e-10</td></tr> <tr><td>7.68e+03</td><td>1.45e-10</td></tr> <tr><td>1.54e+04</td><td>2.33e-10</td></tr> <tr><td>3.07e+04</td><td>1.15e-10</td></tr> <tr><td>6.14e+04</td><td>7.33e-11</td></tr> </tbody> </table>	Tau	Sigma	9.60e+02	1.98e-10	1.92e+03	1.51e-10	3.84e+03	1.51e-10	7.68e+03	1.45e-10	1.54e+04	2.33e-10	3.07e+04	1.15e-10	6.14e+04	7.33e-11
Tau	Sigma																																	
9.60e+02	1.71e-10																																	
1.92e+03	1.23e-10																																	
3.84e+03	1.14e-10																																	
7.68e+03	1.10e-10																																	
1.54e+04	1.03e-10																																	
3.07e+04	9.09e-11																																	
6.14e+04	6.20e-11																																	
Tau	Sigma																																	
9.60e+02	1.98e-10																																	
1.92e+03	1.51e-10																																	
3.84e+03	1.51e-10																																	
7.68e+03	1.45e-10																																	
1.54e+04	2.33e-10																																	
3.07e+04	1.15e-10																																	
6.14e+04	7.33e-11																																	

In the course of correspondence between Erik Dierikx of VSL and Gerard Petit of BIPM it was clarified that the statement of REF DLY and – in consequence thereof – of INT DLY of the VSL receivers was initially not following the rules laid down in the Calibration Guideline [RD02]. VSL decided to adapt its practice to [RD02] and provided the new delay values. All VSL data files kept in storage contain the “old” values. Therefore in Table 12-1 (results table) two lines appear for VSL receivers. The latter one contains the values that are to be used further on. The corrections made by VSL have no impact on the calibration uncertainty. The files in the Annex contain the up-to-date values for delays and coordinates.

## 9. OPERATION OF PTBT AT BEV

PTBT was operated at BEV during almost 6 days, but only 4 completely covered days, MJD 57557 to MJD 57560 (2016-06-18 – 2016-06-21) were used for the evaluation. In parallel, 2 BEV GNSS receivers were operated, with designations BE1\_ and BE3\_ for which internal delays were determined. BE\_1 is a TTS-4 receiver, and for this type of receiver RD02 gives instructions how to state REF DLY. In the original files provided (GMBE1\_MJ.DD we find “REF DLY = 23.20 ns (1PPS DLY: 23.20 ns, phase corr: 0.00 ns)”. Probably the measurement between 1 PPS in and 10 MHz in had not been made. Therefore the statement of REF DLY is not fully consistent with [RD02]. Care must be taken when the installation is changed, as unexpected result could be found. The calibration result and its uncertainty are unaffected. The BEV’s receiver BE2\_ is a single frequency multichannel receiver, and in view of the lack of a calibration procedure, its internal delay was not determined within this campaign. Details on the receivers and their installation are given in the Annex. The installation of the receivers in the BEV time laboratory is illustrated in Figure 9-1. The mounting of the PTBT GNSS antenna at BEV is shown in Figure 9-2.

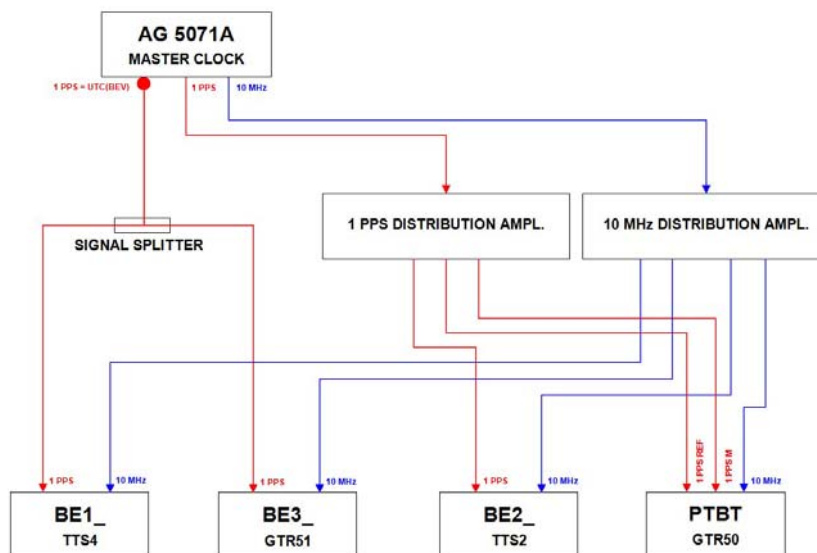

Figure 9-1. Scheme of the installation of the GNSS receivers at BEV



Figure 9-2. Installation of the PTBT antenna at BEV

A first inspection of common-clock common-view data from the two BEV receivers showed an unexpected diurnal signature, as seen in Figure 9-3 where both L1C single frequency data and L3P (ionosphere-free) data are shown. This could possibly be explained by a gross difference in the estimation of the ionospheric delay in the two receivers (of different brand). Using RINEX 2.1 files provided from both receivers allowed the determination of the antenna coordinates, and it turned out that one value in the CCGTTS files of BE3\_ was wrong by 1.15 m. When this was corrected for, the signature in CV data disappeared. In order to accomplish this, new CCGTTS files were generated from RINEX 2.1 files using R2CGGTTS v5.1. In order to remain consistent, also the PTBT position at BEV was newly determined. As this process requires RINEX files of days  $k$  and  $k+1$  for the generation of a CCGTTS file of day  $k$ , in the end only three days of data were available for the determination of the INT DLY ( $\Pi$ ) delays for the two BEV receivers. With this approach, however, all coordinates used were generated in a consistent way using the same procedure. The internal delays of both BEV receivers were finally calculated using the newly determined coordinates and using a corrected value for the BE1\_ REF DLY which was provided by BEV. In the Annex, only the updated tables of receiver parameters that were actually used are given. In correspondence between BEV and BIPM it was clarified that the BE1\_ REF DLY value was determined not in full adherence to [RD02]. The TTS4 installation imposes a measurement of the quantity “phase corr” which did not happen. BEV wished nevertheless that for the sake of continuity the situation is taken as is and delay values are reported as REF DLY and newly determined INT DLY in the future.

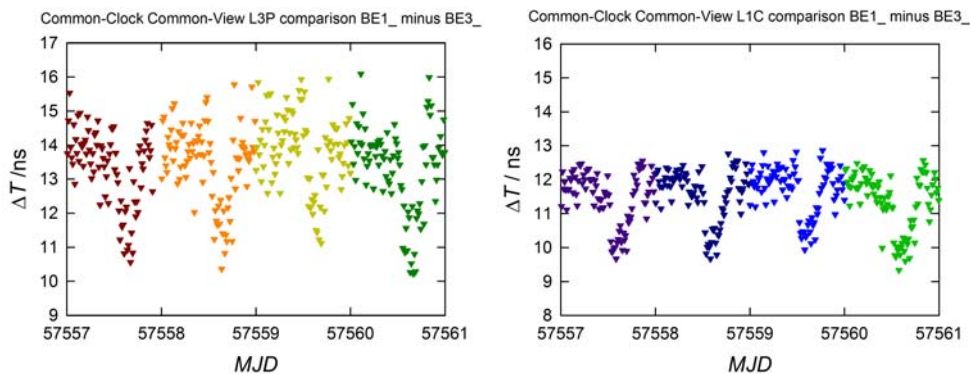

Figure 9-3. Common-clock Common view comparison between the two receivers of BEV based on their original CCGTTS files.

The  $\Delta\Pi$  data are depicted in Figure 9-4. In Table 9-1 the results obtained for the  $\Delta$ INT DLY( $\Pi$ ) values obtained with respect to the initial PTBT values and their statistical uncertainty are collected. The TDEV plots are shown in Table 9-2.

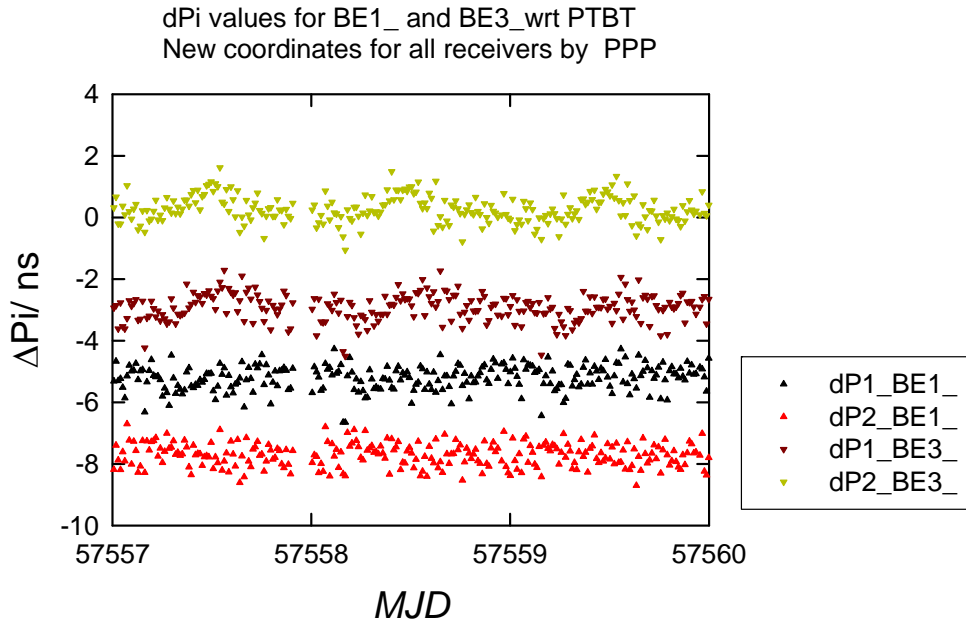
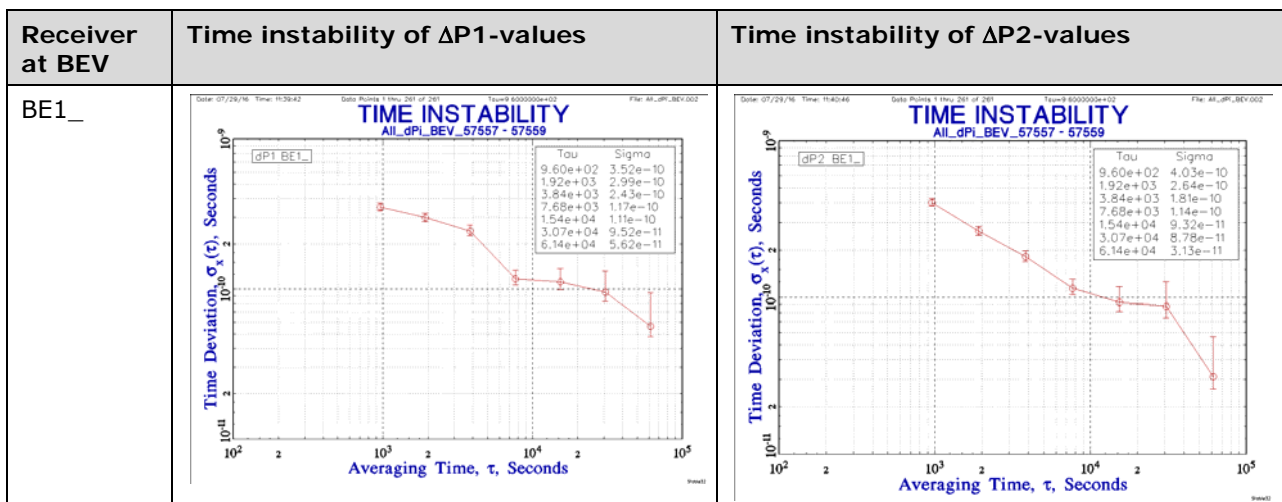

Figure 9-4.  $\Delta Pi$ -values recorded between PTBT and 2 GNSS receivers at BEV

Table 9-1.  $\Delta INT$  DLY( $Pi$ ) values and statistical properties obtained initially. TDEV values are estimates based on the graphs shown in Figure 9-4.

$\Delta INT$ DLY( $Pi$ ) for receiver at BEV	Mean / ns	Median / ns	Std.Dev. / ns	TDEV / ns	Number of epochs
BE1_ P1	-5.21	-5.15	0.40	0.1	261
BE1_ P2	-7.71	-7.68	0.38	0.1	261
BE3_ P1	-2.93	-2.90	0.44	0.25	261
BE3_ P2	0.26	0.23	0.43	0.25	261

Table 9-2. Time instability of the  $\Delta Pi$ -values obtained for the two GNSS receivers at BEV with reference to receiver PTBT



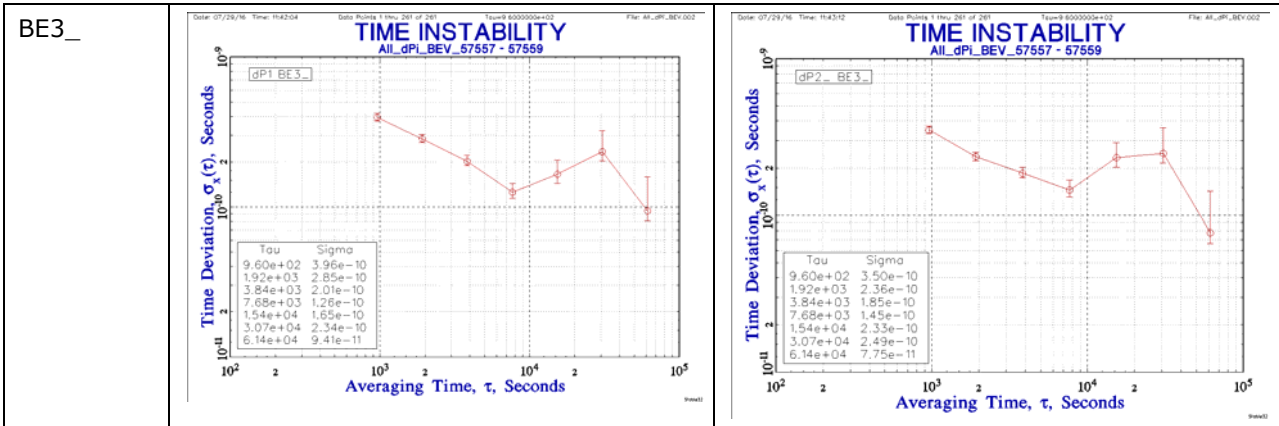



## 10. OPERATION OF PTBT AT PTB: SECOND PERIOD

The period 57575 to 57581 (7 days) was chosen to determine PTBT INT DLY values during the common clock period CC2. The result of comparison with PT02 as the reference are shown in Figure 10-1 illustrating in total 611  $\Delta P_i$  (see eq. 3) values obtained as mean over all common view observations at a given epoch. The time instability (TDEV) plots for the two data sets follow as Figure 10-2. On first sight there seems little difference between the two data sets collected at CC1 and CC2. There is, however a 1.1-ns step in  $\Delta P_1$  between the two periods which is discussed further in the following Summary section.

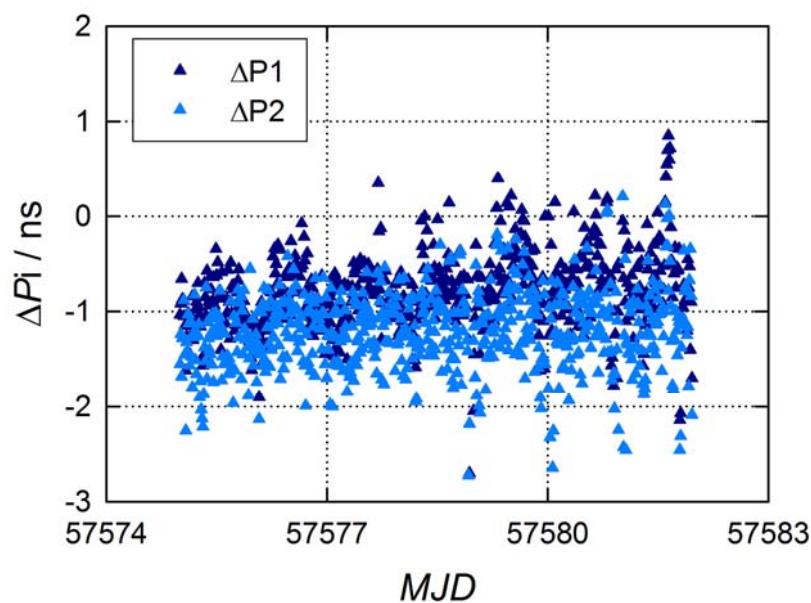

Figure 10-1.  $\Delta P_i$  values obtained during the second common-clock set-up in PTB.

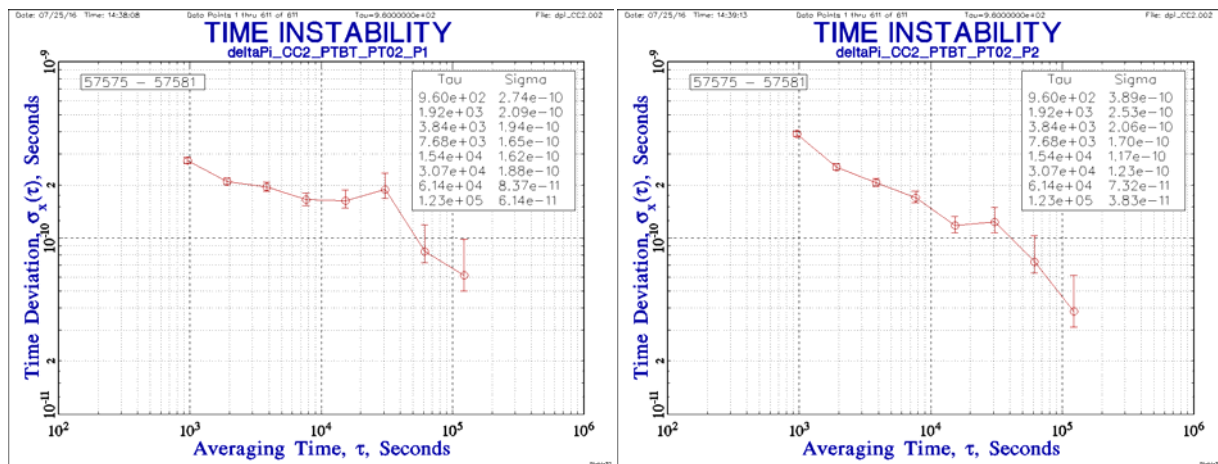

Figure 10-2. TDEV obtained for the two data sets shown in,  $\Delta P_1$  left,  $\Delta P_2$  right.

### 10.1. SUMMARY

The numerical result of the two common-clock campaigns at PTB are given in Table 10-1. The largest change noted between CC1 and CC2 amounts to 1.1 ns for  $\Delta P_1$ . Translated to the

expected P3 time differences, the  $\Delta P3$  change amounts to 2.98 ns, and this is clearly visible in the common-clock, common view time differences shown in Figure 10-3. Here we note a large  $\Delta T$ -step for PTBT - PT02, and a somewhat smaller step in PTBT - PT07. This can be explained by a delay variation in PT02 during the 5-months campaign, that is apparent in the comparisons of PT02 with PT03 and PT07, respectively, shown in addition in Figure 10-3. For the evaluation of the delays of the visited receivers the mean values for  $\Delta P1$ ,  $\Delta P2$  are used. The estimate of the uncertainty contribution is given in Section 11. after Table 11-1.

Table 10-1: Result of common clock measurements at PTB

Quantity	Median (ns)	Sigma (ns)	TDEV (ns)
$\Delta P1$ (CC1)	-1.9	0.46	0.1
$\Delta P2$ (CC1)	-1.4	0.52	< 0.1
$\Delta P3$ (CC1)	-2.67		
$\Delta P1$ (CC2)	-0.8	0.41	0.2
$\Delta P2$ (CC2)	-1.2	0.41	0.1
$\Delta P3$ (CC2)	0.18		
<b>Mean value, used for the evaluation of the calibration campaign results</b>			
$\Delta P1$	-1.35		
$\Delta P2$	-1.3		

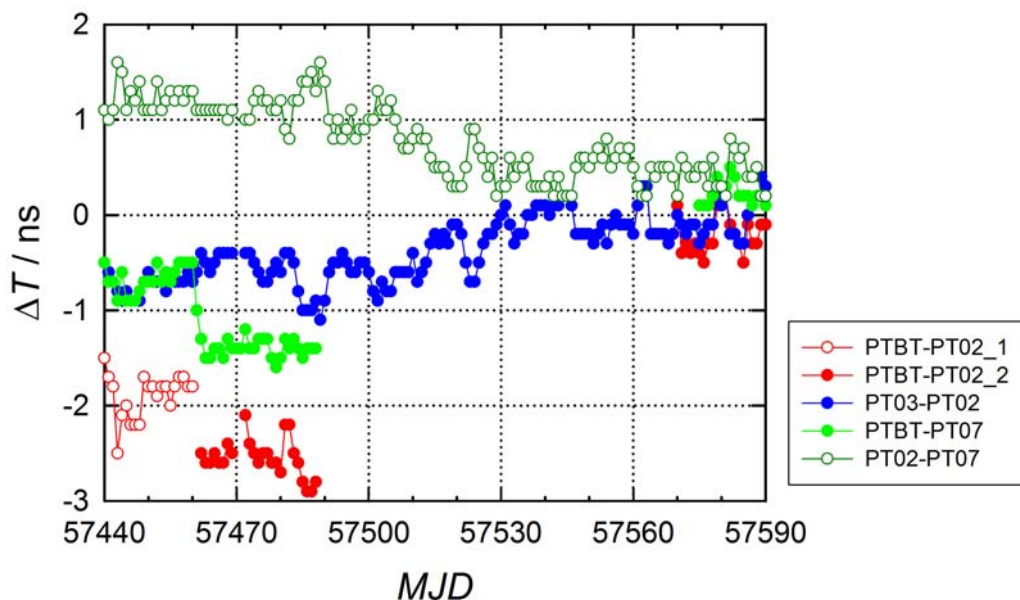

Figure 10-3. Common-clock common-view comparison spanning 5 months, daily mean values

## 11. INT DLY UNCERTAINTY ESTIMATION

The overall uncertainty of the INT DLY values obtained as a result of the calibration is given by

$$u_{\text{CAL}} = \sqrt{u_a^2 + u_b^2}, \quad (6)$$

with the statistical uncertainty  $u_a$  and the systematic uncertainty  $u_b$ . The statistical uncertainty is related to the instability of the common clock data collected at each site and collected at PTB when the INT DLY of PTBT was determined. The systematic uncertainty is given by

$$u_b = \sqrt{\sum_n u_{b,n}^2}. \quad (7)$$

The contributions to the sum (7) are listed and explained subsequently. In the table, extra lines (a, b, c,...) are introduced for the different receivers calibrated at the various sites, and sites are distinguished by colours. Note that the uncertainty of the INT DLY values of PTB's fixed receiver PTBB (G) which served as the reference is not included.

Table 11-1: Uncertainty contributions for the calibration of receiver delays

	Uncertainty	Value P1 (ns)	Value P2 (ns)	Value P1-P2 (ns)	Value P3 (ns)	Description
1	$u_a$ (PTB)	0.2	0.1	0.22	0.40	CC measurement uncertainty at PTB, TDEV at $\tau = 10^4$ s, max. of the two CC campaigns
2a	$u_a$ (DLR)	0.10	0.15	0.18	0.26	CC measurement uncertainty at DLR, receiver OBET
2b	$u_a$ (DLR)	0.10	0.15	0.18	0.26	CC measurement uncertainty at DLR, receiver UTC1
2c	$u_a$ (DLR)	0.10	0.15	0.18	0.26	CC measurement uncertainty at DLR, receiver UTC2
2d	$u_a$ (DLR)	0.10	0.15	0.18	0.26	CC measurement uncertainty at DLR, receiver UTC3
2e	$u_a$ (DLR)	0.10	0.15	0.18	0.26	CC measurement uncertainty at DLR, receiver UTC4
2f	$u_a$ (METAS)	0.1	0.1	0.14	0.24	CC measurement uncertainty at METAS, receiver CH00
2g	$u_a$ (METAS)	0.1	0.1	0.14	0.24	CC measurement uncertainty at METAS, receiver CH01
2h	$u_a$ (VSL)	0.1	0.1	0.14	0.24	CC measurement uncertainty at VSL, receiver VSLF
2i	$u_a$ (VSL)	0.1	0.15	0.18	0.30	CC measurement uncertainty at VSL, receiver VSLG
2k	$u_a$ (BEV)	0.1	0.1	0.14	0.24	CC measurement uncertainty at BEV, receiver BE1_

	Uncertainty	Value P1 (ns)	Value P2 (ns)	Value P1-P2 (ns)	Value P3 (ns)	Description
2m	$u_a(\text{BEV})$	0.25	0.25	0.35	0.74	CC measurement uncertainty at BEV, receiver BE3_
<b>Result of closure measurement at PTB</b>						
3	$u_{b,1}$	0.77	0.14		2.0	Misclosure, see Table 10-1
<b>Systematic components due to antenna installation</b>						
4	$u_{b,11}$	0.1	0.1	0.1	0.25	Position error at PTB
5a	$u_{b,12}(\text{DLR})$	0.1	0.1	0.1	0.25	Position error at DLR
5b	$u_{b,12}(\text{METAS})$	0.1	0.1	0.1	0.25	Position error at METAS
5c	$u_{b,12}(\text{VSL})$	0.15	0.15	0.1	0.25	Position error at VSL
5d	$u_{b,12}(\text{BEV})$	0.1	0.1	0.1	0.25	Position error at BEV
6	$u_{b,13}$	0.1	0.1	0.14	0.24	Multipath at PTB
7	$u_{b,14}$	0.1	0.1	0.14	0.24	Multipath at other sites
<b>Installation of PTBT and visited receivers</b>						
8	$u_{b,21}$	0.2	0.2	0	0.2	Connection of PTBT to UTC(PTB) (REF DLY)
9	$u_{b,22}$	0.2	0.2	0	0.2	Connection of PTBT to UTC(k) (REF DLY)
10	$u_{b,23}$	0.2	0.2	0	0.2	Connection of receivers at site k to UTC(k) (REF DEL)
11	$u_{b,24}$	0.1	0.1	0	0.1	TIC nonlinearities at PTB
12	$u_{b,25}$	0.1	0.1	0	0.1	TIC nonlinearities at other sites
<b>Antenna cable delay</b>						
13a	$u_{b,31}(\text{DLR})$	1.6	1.6	0	1.6	Uncertainty estimate provided by DLR for the CAB DLY used in DLR data
13b	$u_{b,31}(\text{METAS})$	0.5	0.5	0	0.5	Uncertainty estimate provided by METAS for the CAB DLY used in METAS data
13c	$u_{b,31}(\text{VSL})$	0.5	0.5	0	0.5	Uncertainty estimate provided by VSL for the CAB DLY used in VSL data
13d	$u_{b,31}(\text{BEV})$	0.5*	0.5*	0	0.5	Uncertainty estimate provided by BEV for the CAB DLY used in BEV data

Note: \* CAB DLY measurements made by cable / receiver manufacturer, uncertainty unknown

The uncertainty contribution  $u_{b,1}$  is based on the difference between the two common clock campaigns in the following way. As the cause is not understood, and the values for P1 and P2 are quite different, a common cause (that would make the difference P1-P2 insensitive to the effect) should be excluded. We use the standard deviation of the two values around the mean value as measure for the uncertainty and treat them as statistically independent contributions.

For the generation of the CGGTTS data the PTBT antenna position is manually entered into the processing software in ITRF coordinates before the CCD measurements. These positions could in principle differ from the “true” positions in a different way in each laboratory. This is taken into account by the contributions  $u_{b,11}$  and  $u_{b,12}$ . In the current campaign it was confirmed that the antenna coordinates were determined for all masts involved consistently and the contribution is 0.1 ns at maximum. At VSL, established antenna coordinates are combined with a new set for PTBT, therefore the contribution is slightly larger. As a matter of fact, a position error in general could even affect the P1 and P2 delays in a slightly different way, if the distinction between Antenna Reference Point (ARP) and Antenna Phase Centre (APC) is not accurately made. It has been reported that the difference between the two quantities is different for each antenna type but in addition also for the two frequencies received. To be on the safe side,  $u_{b,11}$  and  $u_{b,12}$  are very conservatively estimated. For other entries, where a frequency dependence can be safely excluded, the entry for P1-P2 is set to zero.

An uncertainty contribution due to potential multipath disturbance is added as  $u_{b,13}$  and  $u_{b,14}$ . If at a given epoch in time the recorded time differences REFSYS would be biased by multipath, this might change with time due to the change in the satellite constellation geometry. [RD05] gives an estimate that has often been referred to. In deviation thereof, for the current campaign the following approach was used: Three days of PTBT REFSYS data (column REFGPS in PTBT CGGTTS files from MJD 57486 to 57488) were averaged with three different elevation masks: 10°, 20° and 35°. The results are shown in Table 11-2. The largest difference occurs between the two entries in bold face. The conditions for the installation of the GPS-antennae at all sites are likely more favourable than in PTB (see Figure 4-4), so that the same uncertainty contribution (0,1 ns for P1 and P2) for each site is considered as an upper limit. On the other hand, the type of study made may not give the complete truth on the effect of multipath. Here institutes are encouraged to undertake further studies and publish their findings.

Table 11-2: Elevation dependence of GPS P3 time differences (REFYS) with PTBT at PTB

Day	REFSYS >10° (ns)	N <sub>obs</sub>	Sigma (ns)	REFSYS >20° (ns)	N <sub>obs</sub>	Sigma (ns)	REFSYS >35° (ns)	N <sub>obs</sub>	Sigma (ns)
57486	-2.80	681	2.42	-2.75	602	2.34	-2.75	386	2.24
57487	<b>-3.22</b>	681	2.27	-3.10	602	2.15	<b>-3.03</b>	386	1.87
57488	-2.56	693	2.16	-2.58	610	2.10	-2.65	390	1.83

The uncertainties of the connection of the receivers to the local time scales ( $u_{b,21}$ ,  $u_{b,22}$ ,  $u_{b,23}$ ) are equal but of different origin. As the same counter is employed for the PTBT REF DLY measurements at all sites, the counter’s internal measurement uncertainty for time interval need not be considered.  $u_{b,21}$  was estimated by PTB: The cable connecting UTC(PTB) to PTBT is repeatedly controlled and has been used in many calibration exercises. The visited institutes were requested to state the uncertainty of their connection of PTBT and their own receivers to their local time scale, and this is reflected in  $u_{b,22}$ ,  $u_{b,23}$ . The value 0.2 ns has been included in Table 11-1 which is less favourable than stated in some cases. But this value seems justified, noting the spread of values obtained for the measurement of a nominally 266.5 ns cable delay performed as part of the campaign at the visited institutes.

The uncertainty contributions  $u_{b,24}$  and  $u_{b,25}$  are related to imperfections in the TIC in conjunction with the relationship between the zero-crossings of the external reference frequency and the 1 PPS signals. This “nonlinearity” is probably caused by the internal interpolation process. By

connecting the travelling TIC successively to 5 MHz and 10 MHz generated by different clocks (masers, commercial caesium clocks), respectively, the effect was estimated to be at most 0.1 ns if 1 PPS signals with a slew rate of approximately 0.5 V/ns are used.

The measurement of antenna cable delays is usually done with an uncertainty of 0.5 ns. There is no contribution from the PTBT antenna cable as the same cable and the same value for CAB DLY in the CGGTTS files was used throughout the campaign. Even if this delay was determined with an error, the calibration result is unaffected. The term  $u_{b,31}$  was requested from the institutes. Note that this uncertainty contribution a priori has no impact on the uncertainty of the time transfer link between PTB and the visited institutes. If the started CAB DLY is erroneous this is compensated in the INT DLY values produced as a result of the campaign.

## 12. FINAL RESULTS

The results of the calibration campaign G1G2\_1012\_2016 are summarized in Table 12-1. It contains the designation of visited receiver, the INT DLY values hitherto used, the offsets  $\Delta P_i(V,T)$  and  $\Delta P_i(T,G)$  (see Section 5, (5)), the new INT DLY values to be used with consent by BIPM, and the uncertainty with which the new values were determined. In case of VSL, the lines in red contain the values hitherto used and the results of initial calculations, the lines in black contain the valid result agreed between VSL and BIPM. For calculation the respective entries from Table 11-1, individually for P1, P2, and combined for P3, were used.

**Table 12-1. Results of the Calibration Campaign G1G2\_1012\_2016, all values in ns**

Receiver	INT DLY(P1), old	INT DLY(P2); old	$\Delta P_1(V,T)$	$\Delta P_2(V,T)$	$\Delta P_1(T,G)$	$\Delta(P_2)(T,G)$	INT DLY(P1), new	$u_{cal}, P1$	INT DLY(P2), new	$u_{cal}, P2$	$u_{cal}, P3$	$u_{cal}, P3$ without $u_{b,31}$
DLR, OBET	0	0	59.15	57.41	-1.35	-1.30	57.80	1.8	56.11	1.6	2.6	2.1
DLR, UTC1	0	0	202.92	202.02	-1.35	-1.30	201.57	1.8	200.9	1.6	2.6	2.1
DLR, UTC2	0	0	206.71	199.07	-1.35	-1.30	205.56	1.8	197.77	1.6	2.6	2.1
DLR, UTC3	0	0	209.5	199.43	-1.35	-1.30	208.15	1.8	198.13	1.6	2.6	2.1
DLR, UTC4	0	0	59.64	57.98	-1.35	-1.30	58.29	1.8	56.68	1.7	2.6	2.1

Receiver	INT DLY(P1), old	INT DLY(P2); old	$\Delta P1$ (V,T)	$\Delta P2$ (V,T)	$\Delta P1$ (T,G)	$\Delta(P2)$ (T,G)	INT DLY(P1), new	$u_{cal, P1}$	INT DLY(P2), new	$u_{cal, P2}$	$u_{cal, P3}$	$u_{cal, P3}$ without $u_{b,31}$
METAS, CH00	55.6	59.4	-3.54	-4.79	-1.35	-1.3	50.71	1.0	53.31	0.6	2.2	2.1
METAS, CH01	297.4	315.2	2.81	1.69	-1.35	.1.30	298.86	1.0	315.59	0.6	2.2	2.1
VSL, VSLF	-114.5	-114.5	15.17	23.65	-1.35	-1.30	-100.68	1.0	-92.15	0.6	2.2	2.1
	38.7	38.7	15.17	23.65	-1.35	-1.30	52.5	1.0	61.1	0.6	2.2	2.1
VSL, VSLG	-56.2	-56.2	3.85	4.62	-1.35	-1.30	-53.7	1.0	-52.88	0.7	2.2	2.1
	-53.6	-53.6	3.85	4.62	-1.35	-1.30	-51.1	1.0	-50.2	0.7	2.2	2.1
BEV, BE1_	-19.25	-19.01	-5.15	-7.68	-1.35	-1.30	-25.75	1.0	-27.99	0.6	2.2	2.1
BEV, BE3_	-33.4	-35.5	-2.90	0.23	-1.35	-1.30	-37.65	1.1	-36.57	0.7	2.3	2.2

It is obvious that all uncertainty values are dominated by the contribution due to the mis-closure obtained between CC1 and CC2 at PTB, (entry  $u_{b,1}$ ) in Table 11-1.



## ANNEX: BIPM CALIBRATION INFORMATION SHEETS

### First common clock measurement at PTB

<b>Laboratory:</b>		<b>PTB</b>		
Date and hour of the beginning of measurements:		2016-04-04 0:00 UTC (MJD 57482)		
Date and hour of the end of measurements:		2016-04-10 24:00 UTC (MJD 57488)		
<b>Information on the system</b>				
	<b>Local:</b>	<b>Travelling:</b>		
4-character BIPM code	<b>PTBB</b>	<b>PTBT</b>		
Receiver maker and type:	ASHTECH Z-XII3T	Dicom GTR50		
Receiver serial number:	(S/N RT820013901)	0708522 1.7.4		
1 PPS trigger level /V:	1 V	1		
Antenna cable maker and type: Phase stabilised cable (Y/N):	Nokia RG214	Times Microwave Systems LMR-400-UF (N)		
Length outside the building /m:	approx. 25m	25		
Antenna maker and type: Antenna serial number:	Ashtech ASH700936 SNOW (S/N CR15930)	Navexperience 3G+C NA0164		
Temperature (if stabilised) /°C				
<b>Measured delays /ns</b>				
	<b>Local:</b>	<b>Travelling:</b>		
Delay from local UTC to receiver 1 PPS-in ( $X_p$ ) / ns	$20.1 \pm 0.1$ (*)	$62.2 \pm 0.1$ (**)		
Delay from 1 PPS-in to internal Reference (if different): ( $X_o$ ) / ns	$38.0 \pm 0.1$	N/A		
Antenna cable delay: ( $X_c$ ) / ns	301.7	$266.5 \pm 0.1$ (**)		
Splitter delay (if any):	N/A			
Additional cable delay (if any):	N/A			
<b>Data used for the generation of CGGTTS files</b>				
	<b>LOCAL:</b>	<b>Travelling</b>		
<input type="checkbox"/> INT DLY (or $X_R+X_S$ ) (GPS) /ns:	303.9 (P1), 319.3 (P2)	-42.6 (P1) -49.1 (P2)		
<input type="checkbox"/> INT DLY (or $X_R+X_S$ ) (GLONASS) /ns:				
<input type="checkbox"/> CAB DLY (or $X_c$ ) /ns:	301.7	266.5		
<input type="checkbox"/> REF DLY (or $X_p+X_o$ ) /ns:	74.0 (*)	62.2		
<input type="checkbox"/> Coordinates reference frame:	ITRF (*)	ITRF (***)		
X /m:	+3844059.89 (*)	Mast P10	+3844057.71	Mast P11
Y /m:	+709661.48 (*)		+709663.27 (***)	
Z /m	+5023129.73 (*)		+5023131.14 (***)	

General information	
<input type="checkbox"/> Rise time of the local UTC pulse:	3 ns
<input type="checkbox"/> Is the laboratory air conditioned:	yes
Set temperature value and uncertainty:	

Notes:

(\*) values provided by BIPM as part of coordinate alignment 2014 and G1 calibration  
 Cal\_Id=1001-2014

(\*\*) Use of the same counter and receiver throughout the campaign suppresses major systematic uncertainty contributions

(\*\*\*) INT DLY adjusted after publication of results Ca\_Id=1001-2014, coordinates interpolated from BIPM results for neighbouring masts

Names of files to be used in processing for site PTB CC1

Local receiver: GZPT02MJ.DDD

Travelling receiver GZPTBTMJ.DDD

## Site 1: PTBT at DLR IKN – Receiver UTC1

<b>Laboratory:</b>		<b>DLR</b>	
Date and hour of the beginning of measurements:	19.04.2016 15:00 UTC		
Date and hour of the end of measurements:	24.04.2016 24:00 UTC		
<b>Information on the system</b>			
	<b>Local:</b>	<b>Travelling:</b>	
4-character BIPM code	<b>UTC1</b>	<b>PTBT</b>	
Receiver maker and type:	Septentrio PolaRx2TR	Dicom GTR50	
Receiver serial number:	1209	0708522 1.7.4	
1 PPS trigger level /V:	1	1	
Antenna cable maker and type: Phase stabilised cable (Y/N):	SSB ECOFLEX 15 (N)	Times Microwave Systems LMR-400-UF (N)	
Length outside the building /m:	15	15	
Antenna maker and type: Antenna serial number:	Novatel GNSS750 NMBJ13490005V	Navexperience 3G+C NA0164	
Temperature (if stabilised) /°C	no		
<b>Measured delays /ns</b>			
	<b>Local:</b>	<b>Travelling:</b>	
Delay from local UTC to receiver PPS-in ( $X_P$ ) / ns	12.2	19.9	
Delay from 1 PPS-in to internal Reference (if different): ( $X_O$ ) /(ns)	233.6	N/A	
Antenna cable delay: ( $X_C$ ) /ns	510.7	266.5	
Splitter delay (if any):	3.0		
Additional cable delay (if any):	10.3		
<b>Data used for the generation of CGGTTS files</b>			
	<b>LOCAL:</b>	<b>Travelling</b>	
<input type="checkbox"/> INT DLY (or $X_R+X_S$ ) (GPS) /ns:	(P1) (P2)	-42.6 (P1) -49.1 (P2)	
<input type="checkbox"/> INT DLY (or $X_R+X_S$ ) (GLONASS) /ns:			
<input type="checkbox"/> CAB DLY (or $X_C$ ) /ns:	524.0 (510.7+3+10.3)**	266.5	
<input type="checkbox"/> REF DLY (or $X_P+X_O$ ) /ns:	245.8	19.9	
<input type="checkbox"/> Coordinates reference frame:	ITRF05 (2016.30 (years))	ITRF05 (2016.30 (years))	
X /m:	+ 4186708.561	DLR2	+ 4186708.236
Y /m:	+ 834902.584		+ 834904.557
Z /m	+ 4723667.310		+ 4723667.244
<b>General information</b>			
<input type="checkbox"/> Rise time of the local UTC pulse:	3 ns		
<input type="checkbox"/> Is the laboratory air conditioned:	yes		
Set temperature value and uncertainty:	(21.4 +/- 0.2)°C		

Notes:

\*\*"Für beide Empfänger habe ich die gleiche Messmethode mit TIC verwendet und habe für das Kabel Antenne -> Splitter  $\sqrt{1.5^2 + 0.2^2} = 1,6\text{ns}$  und für das Kabel Splitter -> Empfänger OBET / UTC4 jeweils 0.1ns,, E-Mail 23.06.2016, J. Furthner

Names of files to be used in processing (for site DLR): Local receiver: UTC1DOY0.YY0, Travelling receiver GZPTBMJ.DDD.  
Comments: ^

## Site 1: PTBT at DLR IKN – Receiver UTC2

<b>Laboratory:</b>		<b>DLR</b>	
Date and hour of the beginning of measurements:		19.04.2016 15:00 UTC	
Date and hour of the end of measurements:		24.04.2016 24:00 UTC	
<b>Information on the system</b>			
	<b>Local:</b>	<b>Travelling:</b>	
4-character BIPM code	<b>UTC2</b>	<b>PTBT</b>	
Receiver maker and type:	Septentrio PolaRx2TR	Dicom GTR50	
Receiver serial number:	1271	0708522 1.7.4	
1 PPS trigger level /V:	1	1	
Antenna cable maker and type: Phase stabilised cable (Y/N):	SSB ECOFLEX 15 (N)	Times Microwave Systems LMR-400-UF (N)	
Length outside the building /m:	15	15	
Antenna maker and type: Antenna serial number:	Novatel GNSS750 NMBJ13490005V	Navexperience 3G+C NA0164	
Temperature (if stabilised) /°C	no		
<b>Measured delays /ns</b>			
	<b>Local:</b>	<b>Travelling:</b>	
Delay from local UTC to receiver PPS-in ( $X_p$ ) / ns	12.1	19.9	
Delay from 1 PPS-in to internal Reference (if different): ( $X_o$ )/ns	232.7	N/A	
Antenna cable delay: ( $X_c$ ) / ns	510.7	266.5	
Splitter delay (if any) / ns:	3.0		
Additional cable delay (if any):	12.1		
<b>Data used for the generation of CGGTS files</b>			
	<b>LOCAL:</b>	<b>Travelling</b>	
<input type="checkbox"/> INT DLY (or $X_R+X_S$ ) (GPS) /ns:	(P1) (P2)	-42.6 (P1) -49.1 (P2)	
<input type="checkbox"/> INT DLY (or $X_R+X_S$ ) (GLONASS) /ns:			
<input type="checkbox"/> CAB DLY (or $X_c$ ) /ns:	525.8 (510.7+3+12.1)	266.5	
<input type="checkbox"/> REF DLY (or $X_p+X_o$ ) /ns:	244.9	19.9	
<input type="checkbox"/> Coordinates reference frame:	ITRF05 (2016.30 (years))	ITRF05 (2016.30 (years))	
X /m:	+ 4186708.561	DLR2	+ 4186708.236
Y /m:	+ 834902.584		+ 834904.557
Z /m	+ 4723667.310		+ 4723667.244
<b>General information</b>			
<input type="checkbox"/> Rise time of the local UTC pulse:	3 ns		
<input type="checkbox"/> Is the laboratory air conditioned:	yes		
Set temperature value and uncertainty:	(21.4 +/- 0.2)°C		

Names of files to be used in processing (for site DLR): Local receiver: UTC2DOY0.YYy,  
 Travelling receiver GZPTBTMJ.DDD.

## Site 1: PTBT at DLR IKN – Receiver UTC3

<b>Laboratory:</b>		<b>DLR</b>	
Date and hour of the beginning of measurements:	19.04.2016 15:00 UTC		
Date and hour of the end of measurements:	24.04.2016 24:00 UTC		
<b>Information on the system</b>			
	<b>Local:</b>	<b>Travelling:</b>	
4-character BIPM code	<b>UTC3</b>	<b>PTBT</b>	
Receiver maker and type:	Septentrio PolaRx2TR	Dicom GTR50	
Receiver serial number:	2128	0708522 1.7.4	
1 PPS trigger level /V:	1	1	
Antenna cable maker and type: Phase stabilised cable (Y/N):	SSB ECOFLEX 15 (N)	Times Microwave Systems LMR-400-UF (N)	
Length outside the building /m:	15	15	
Antenna maker and type: Antenna serial number:	Novatel GNSS750 NMBJ13490005V	Navexperience 3G+C NA0164	
Temperature (if stabilised) /°C	no		
<b>Measured delays /ns</b>			
	<b>Local:</b>	<b>Travelling:</b>	
Delay from local UTC to receiver PPS-in ( $X_p$ ) /ns	8.2	19.9	
Delay from 1 PPS-in to internal Reference (if different): ( $X_o$ ) / ns	232.7	N/A	
Antenna cable delay: ( $X_c$ ) / ns	510.7	266.5	
Splitter delay (if any): / ns	3.0		
Additional cable delay (if any): / ns	12.2		
<b>Data used for the generation of CGGTTS files</b>			
	<b>LOCAL:</b>	<b>Travelling</b>	
<input type="checkbox"/> INT DLY (or $X_R+X_S$ ) (GPS) /ns:	(P1) (P2)	-42.6 (P1) -49.1 (P2)	
<input type="checkbox"/> INT DLY (or $X_R+X_S$ ) (GLONASS) /ns:			
<input type="checkbox"/> CAB DLY (or $X_c$ ) /ns:	525.9 (510.7+3+12.2)	266.5	
<input type="checkbox"/> REF DLY (or $X_p+X_o$ ) /ns:	242.7	19.9	
<input type="checkbox"/> Coordinates reference frame:	ITRF05 (2016.30 (years))	ITRF05 (2016.30 (years))	
X /m:	+ 4186708.561	DLR2	+ 4186708.236
Y /m:	+ 834902.584		+ 834904.557
Z /m	+ 4723667.310		+ 4723667.244
<b>General information</b>			
<input type="checkbox"/> Rise time of the local UTC pulse:	3 ns		
<input type="checkbox"/> Is the laboratory air conditioned:	yes		
Set temperature value and uncertainty:	(21.4 +/- 0.2)°C		

Names of files to be used in processing (for site DLR): Local receiver: UTC3DOY0.YYy  
 Travelling receiver GZPTBTMJ.DDD.

## Site 1: PTBT at DLR IKN – Receiver UTC4

<b>Laboratory:</b>		<b>DLR</b>	
Date and hour of the beginning of measurements:	19.04.2016 15:00 UTC		
Date and hour of the end of measurements:	24.04.2016 24:00 UTC		
<b>Information on the system</b>			
	<b>Local:</b>	<b>Travelling:</b>	
4-character BIPM code	<b>UTC4</b>	<b>PTBT</b>	
Receiver maker and type:	Septentrio PolaRx4TR Pro	Dicom GTR50	
Receiver serial number:	3001354	0708522 1.7.4	
1 PPS trigger level /V:	1	1	
Antenna cable maker and type: Phase stabilised cable (Y/N):	SSB ECOFLEX 15 (N)	Times Microwave Systems LMR-400-UF (N)	
Length outside the building /m:	15	15	
Antenna maker and type: Antenna serial number:	Novatel GNSS750 NMBJ13490005V	Navexperience 3G+C NA0164	
Temperature (if stabilised) /°C	no		
<b>Measured delays /ns</b>			
	<b>Local:</b>	<b>Travelling:</b>	
Delay from local UTC to receiver PPS-in ( $X_p$ ) /ns	8.3	19.9	
Delay from 1 PPS-in to internal Reference (if different): ( $X_o$ ) / ns	131.4	N/A	
Antenna cable delay: ( $X_c$ ) / ns	510.7	266.5	
Splitter delay (if any): / ns	3.0		
Additional cable delay (if any): / ns	12.2		
<b>Data used for the generation of CGGTTS files</b>			
	<b>LOCAL:</b>	<b>Travelling</b>	
<input type="checkbox"/> INT DLY (or $X_R+X_S$ ) (GPS) /ns:	(P1) (P2)	-42.6 ns (P1) -49.1 ns (P2)	
<input type="checkbox"/> INT DLY (or $X_R+X_S$ ) (GLONASS) /ns:			
<input type="checkbox"/> CAB DLY (or $X_c$ ) /ns:	525.9 (510.7+3+12.2)	266.5	
<input type="checkbox"/> REF DLY (or $X_p+X_o$ ) /ns:	139.7 ns	19.9	
<input type="checkbox"/> Coordinates reference frame:	ITRF05 (2016.30 (years))	ITRF05 (2016.30 (years))	
X /m:	+ 4186708.561	DLR2	+ 4186708.236
Y /m:	+ 834902.584		+ 834904.557
Z /m	+ 4723667.310		+ 4723667.244
<b>General information</b>			
<input type="checkbox"/> Rise time of the local UTC pulse:	3 ns		
<input type="checkbox"/> Is the laboratory air conditioned:	yes		
Set temperature value and uncertainty:	(21.4 +/- 0.2)°C		

Names of files to be used in processing (for site DLR): Local receiver: UTC4DOY0.YYy, Travelling receiver GZPTBTMJ.DDD.

## Site 1: PTBT at DLR IKN – Receiver OBET

<b>Laboratory:</b>		<b>DLR</b>	
Date and hour of the beginning of measurements:	19.04.2016 15:00 UTC		
Date and hour of the end of measurements:	24.04.2016 24:00 UTC		
<b>Information on the system</b>			
	<b>Local:</b>	<b>Travelling:</b>	
4-character BIPM code	<b>OBET</b>	<b>PTBT</b>	
Receiver maker and type:	Septentrio PolaRx4TR Pro	Dicom GTR50	
Receiver serial number:	3007660	0708522 1.7.4	
1 PPS trigger level /V:	1	1	
Antenna cable maker and type: Phase stabilised cable (Y/N):	SSB ECOFLEX 15 (N)	Times Microwave Systems LMR-400-UF (N)	
Length outside the building /m:	15	15	
Antenna maker and type: Antenna serial number:	Novatel GNSS750 NMBJ13490005V	Navexperience 3G+C NA0164	
Temperature (if stabilised) /°C	no		
<b>Measured delays /ns</b>			
	<b>Local:</b>	<b>Travelling:</b>	
Delay from local UTC to receiver PPS-in ( $X_p$ ) / ns	12.5 ns	19.9 ns	
Delay from 1 PPS-in to internal Reference (if different) ( $X_o$ ) / ns	148.1	N/A	
Antenna cable delay ( $X_c$ ) / ns	510.7	266.5	
Splitter delay (if any) / ns	3.0		
Additional cable delay (if any) / ns	8.1		
<b>Data used for the generation of CGGTS files</b>			
	<b>LOCAL:</b>	<b>Travelling</b>	
<input type="checkbox"/> INT DLY (or $X_R+X_S$ ) (GPS) /ns:	(P1) (P2)	-42.6 (P1) -49.1 (P2)	
<input type="checkbox"/> INT DLY (or $X_R+X_S$ ) (GLONASS) /ns:			
<input type="checkbox"/> CAB DLY (or $X_c$ ) /ns:	521.8 (510.7+3+ 8.1)	266.5	
<input type="checkbox"/> REF DLY (or $X_p+X_o$ ) /ns:	160.6	19.9	
<input type="checkbox"/> Coordinates reference frame:	ITRF05 (2016.30 (years))	ITRF05 (2016.30 (years))	
X /m:	+ 4186708.561	DLR2	+ 4186708.23
Y /m:	+ 834902.584		+ 834904.557
Z /m	+ 4723667.310		+ 4723667.244
<b>General information</b>			
<input type="checkbox"/> Rise time of the local UTC pulse:	3 ns		
<input type="checkbox"/> Is the laboratory air conditioned:	yes		
Set temperature value and uncertainty:	(21.4 +/- 0.2)°C		

Names of files to be used in processing (for site DLR): Local receiver: OBETDOY0.YY0,  
 Travelling receiver GZPTBTMJ.DDD.



## Site 2: PTBT at METAS

<b>Laboratory:</b>		<b>METAS</b>	
Date and hour of the beginning of measurements:		2016-05-14 UTC 0000	
Date and hour of the end of measurements:		2016-05-21 UTC 24:00	
<b>Information on the system</b>			
	<b>Local:</b>	<b>Travelling:</b>	
4-character BIPM code	<b>CH00</b>	<b>PTBT</b>	
Receiver maker and type:	Septentrio PolaRx3eTR	Dicom GTR50	
Receiver serial number:	2001065	0708522 1.7.4	
1 PPS trigger level /V:	Not specified by Septentrio	1	
Antenna cable maker and type:	Andrews FSJ1-50A	Times Microwave Systems LMR-400-UF (N)	
Phase stabilised cable (Y/N):	Y		
Length outside the building /m:	10 m	10 m	
Antenna maker and type: Antenna serial number:	Ashtech type 700936 (D) CR14349	Navexperience 3G+C NA0164	
Temperature (if stabilised) /°C			
<b>Measured delays /ns</b>			
	<b>Local:</b>	<b>Travelling:</b>	
Delay from local UTC to receiver PPS-in ( $X_p$ ) / ns	(25.2 ± 0.1)	22.8	
Delay from 1 PPS-in to internal Reference (if different) ( $X_o$ ) / ns	(181.2 ± 0.1)	N/A	
Antenna cable delay ( $X_c$ ) / ns	(220.1 ± 0.5)	(265.5 ± 0.5)	
Splitter delay (if any) / ns			
Additional cable delay (if any) / ns			
<b>Data used for the generation of CGGTS files</b>			
	<b>LOCAL:</b>	<b>Travelling</b>	
<input type="checkbox"/> INT DLY (or $X_R+X_S$ ) (GPS) /ns:	55.6 (P1) 59.4 (P2)	-42.6 (P1) -49.1 (P2)	
<input type="checkbox"/> INT DLY (or $X_R+X_S$ ) (GLONASS) /ns:			
<input type="checkbox"/> CAB DLY (or $X_C$ ) /ns:	220.1	266.5	
<input type="checkbox"/> REF DLY (or $X_p+X_o$ ) /ns:	206.4	22.8	
<input type="checkbox"/> Coordinates reference frame:	ITRF 2008 (2016-05-13)	ITRF 2008 (2016-02-03)	
X /m:	+ 4327318.3142	+ 4327322.3886	
Y /m:	+ 566952.1134	+ 566956.1918	
Z /m	+ 4636428.0624	+ 4636423.9720	
<b>General information</b>			
<input type="checkbox"/> Rise time of the local UTC pulse:	1 ns		
<input type="checkbox"/> Is the laboratory air conditioned:	yes		
Set temperature value and uncertainty:	(22.0 ± 1.0) °C		

Names of files to be used in processing (for site METAS):

Local receiver: GZCH00MJ.DDD, travelling receiver GZPTBTMJ.DDD

## Site 2: PTBT at METAS

<b>Laboratory:</b>		<b>METAS</b>	
Date and hour of the beginning of measurements:		2016-05-14 UTC 00:00	
Date and hour of the end of measurements:		2016-05-21 UTC 24:00	
<b>Information on the system</b>			
	<b>Local:</b>	<b>Travelling:</b>	
4-character BIPM code	<b>CH01</b>	<b>PTBT</b>	
Receiver maker and type:	Ashtech Z12T	Dicom GTR50	
Receiver serial number:	RT919993201	0708522 1.7.4	
1 PPS trigger level /V:	Not specified by Ashtech	1	
Antenna cable maker and type:	Andrews FSJ1-50A	Times Microwave Systems LMR-400-UF (N)	
Phase stabilised cable (Y/N):	Y		
Length outside the building /m:	10 m	10 m	
Antenna maker and type: Antenna serial number:	Ashtech type 700936 (F) CR1998390144	Navexperience 3G+C NA0164	
Temperature (if stabilised) /°C			
<b>Measured delays /ns</b>			
	<b>Local:</b>	<b>Travelling:</b>	
Delay from local UTC to receiver PPS-in ( $X_p$ ) / ns	(11.8 ± 0.1) ns	22.8	
Delay from 1 PPS-in to internal Reference (if different) ( $X_o$ ) / ns	(32.5 ± 0.1) ns	N/A	
Antenna cable delay ( $X_c$ ) / ns	(213.4 ± 0.5) ns	(265.5 ± 0.5) ns	
Splitter delay (if any) / ns			
Additional cable delay (if any) / ns			
<b>Data used for the generation of CGGTS files</b>			
	<b>LOCAL:</b>	<b>Travelling</b>	
<input type="checkbox"/> INT DLY (or $X_R+X_S$ ) (GPS) /ns:	297.4 (P1) 315.2 (P2)	-42.6 (P1) -49.1 (P2)	
<input type="checkbox"/> INT DLY (or $X_R+X_S$ ) (GLONASS) /ns:			
<input type="checkbox"/> CAB DLY (or $X_C$ ) /ns:	213.4	266.5	
<input type="checkbox"/> REF DLY (or $X_p+X_o$ ) /ns:	44.2	22.8	
<input type="checkbox"/> Coordinates reference frame:	ITRF 2008 (2016-05-13)	ITRF 2008 (2016-02-03)	
X /m:	+ 4327319.1032	+ 4327322.3886	
Y /m:	+ 566956.0556	+ 566956.1918	
Z /m	+ 4636426.8389	+ 4636423.9720	
<b>General information</b>			
<input type="checkbox"/> Rise time of the local UTC pulse:	1 ns		
<input type="checkbox"/> Is the laboratory air conditioned:	yes		
Set temperature value and uncertainty:	(22.0 ± 1.0) °C		

Names of files to be used in processing (for site METAS):

Local receiver: GZCH01MJ.DDD, travelling receiver GZPTBTMJ.DDD

## Site 3: PTBT at VSL

<b>Laboratory:</b>		<b>VSL</b>	
Date and hour of the beginning of measurements:		02-06-2016 18:00 UTC	
Date and hour of the end of measurements:		07-06-2016 12:00 UTC	
<b>Information on the system</b>			
	<b>Local:</b>	<b>Travelling:</b>	
4-character BIPM code	<b>VSLF</b>	<b>PTBT</b>	
Receiver maker and type:	Septentrio PolaRx4TR	Dicom GTR50	
Receiver serial number:	3001395	0708522 1.7.4	
1 PPS trigger level /V:	?	1	
Antenna cable maker and type: Phase stabilised cable (Y/N):	SSB Electronic GmbH, Aircom Plus (N)	Times Microwave Systems LMR- 400-UF (N)	
Length outside the building /m:	10 m	8 m	
Antenna maker and type: Antenna serial number:	Topcon TPSCR.G3 (TPSH) 383-1235	Navexperience 3G+C NA0164	
Temperature (if stabilised) /°C	N/A	N/A	
<b>Measured delays /ns</b>			
	<b>Local:</b>	<b>Travelling:</b>	
Delay from local UTC to receiver PPS-in ( $X_p$ ) / ns	34.1	28.4	
Delay from 1 PPS-in to internal Reference (if different) ( $X_o$ ) / ns	153.2	N/A	
Antenna cable delay ( $X_c$ ) / ns	124.7	266.5	
Splitter delay (if any):	N/A	N/A	
Additional cable delay (if any):	N/A	N/A	
<b>Data used for the generation of CGGTS files</b>			
	<b>LOCAL:</b>	<b>Travelling</b>	
<input type="checkbox"/> INT DLY (or $X_R+X_S$ ) (GPS) /ns:	38.7 (P1) 38.7 (P2)	-42.6 (P1) -49.1 (P2) )	
<input type="checkbox"/> INT DLY (or $X_R+X_S$ ) (GLONASS) /ns:	N/A		
<input type="checkbox"/> CAB DLY (or $X_C$ ) /ns:	124.7	266.5	
<input type="checkbox"/> REF DLY (or $X_p+X_o$ ) /ns:	187.3	28.4	
<input type="checkbox"/> Coordinates reference frame:	ITRF	ITRF	
X /m:	+3924692.74 m		+3924688.99 m
Y /m:	+301141.03 m		+301145.74 m
Z /m	+5001908.26 m		+5001909.12 m
<b>General information</b>			
<input type="checkbox"/> Rise time of the local UTC pulse:	0.75 ns		
<input type="checkbox"/> Is the laboratory air conditioned:	yes		
Set temperature value and uncertainty:	23.0 ± 0.2 °C		

Names of files to be used in processing (for site VSL): Local receiver: GZVS06MJ.DDD, travelling receiver GZPTBTMJ.DDD

Comments:

Coordinates of the PTBT antenna have been initially estimated from the position of the antenna in the 2012 calibration:

The position then was:

$X = 3924689.031$  m,  $Y = 301145.681$  m,  $Z = 5001909.071$  m.

With a height correction of 20 cm for the additional extender, the position is:

$X = 3924689.154$  m,  $Y = 301145.691$  m,  $Z = 5001909.228$  m.

From the NRCAN PPP analysis of the data from 4 June and 6 June 2016, the actual coordinates of the PTBT antenna were derived:

$X = 3924688.99$  m,  $Y = 301145.74$  m,  $Z = 5001909.12$  m.

<b>Laboratory:</b>		<b>VSL</b>	
Date and hour of the beginning of measurements:	02-06-2016 18:00 UTC		
Date and hour of the end of measurements:	07-06-2016 12:00 UTC		
<b>Information on the system</b>			
	<b>Local:</b>	<b>Travelling:</b>	
4-character BIPM code	<b>VSLG</b>	<b>PTBT</b>	
Receiver maker and type:	JAVAD Delta TRE 3.4	Dicom GTR50	
Receiver serial number:	02336	0708522 1.7.4	
1 PPS trigger level /V:	?	1	
Antenna cable maker and type:	SSB Electronic GmbH,	Times Microwave Systems LMR-	
Phase stabilised cable (Y/N):	Aircom Plus (N)	400-UF (N)	
Length outside the building /m:	10 m	8 m	
Antenna maker and type: Antenna serial number:	Topcon TPSCR3_GGD 2170239	Navexperience 3G+C NA0164	
Temperature (if stabilised) /°C	N/A	N/A	
<b>Measured delays /ns</b>			
	<b>Local:</b>	<b>Travelling:</b>	
Delay from local UTC to receiver PPS-in ( $X_p$ ) / ns	33.6	28.4	
Delay from 1 PPS-in to internal Reference (if different) ( $X_o$ ) / ns	2.6	N/A	
Antenna cable delay ( $X_c$ ) / ns	124.8	266.5	
Splitter delay (if any):	N/A	N/A	
Additional cable delay (if any):	N/A	N/A	
<b>Data used for the generation of CGGTTS files</b>			
	<b>LOCAL:</b>	<b>Travelling</b>	
<input type="checkbox"/> INT DLY (or $X_R+X_S$ ) (GPS) /ns:	-53.6 (P1) -53.6 (P2)	-42.6 (P1) -49.1 (P2) )	
<input type="checkbox"/> INT DLY (or $X_R+X_S$ ) (GLONASS) /ns:	N/A	N/A	
<input type="checkbox"/> CAB DLY (or $X_C$ ) /ns:	124.8	266.5	
<input type="checkbox"/> REF DLY (or $X_p+X_o$ ) /ns:	36.2	28.4	
<input type="checkbox"/> Coordinates reference frame:	ITRF	ITRF	
X /m:	+3924691.71 m	+3924688.99 m	
Y /m:	+301143.31 m	+301145.74 m	
Z /m	+5001908.88 m	+5001909.12 m	
<b>General information</b>			
<input type="checkbox"/> Rise time of the local UTC pulse:	0.75 ns		
<input type="checkbox"/> Is the laboratory air conditioned:	yes		
Set temperature value and uncertainty:	23.0 ± 0.2 °C		

Names of files to be used in processing: Local receiver: VS07MJDDD.gps, travelling receiver: GZPTBTMJ.DDD, previous comments apply regarding PTBT coordinates.

## Site 4: PTBT at BEV

<b>Laboratory:</b>		<b>BEV</b>	
Date and hour of the beginning of measurements:		2016-06-17 14:26 UTC (MJD 57556)	
Date and hour of the end of measurements:		2016-06-22 08:50 UTC (MJD 57561)	
<b>Information on the system</b>			
	<b>Local:</b>	<b>Travelling:</b>	
4-character BIPM code	BE1_	PTBT	
Receiver maker and type:	Piktime TTS-4	Dicom GTR50	
Receiver serial number:	0128	0708522 1.7.4	
1 PPS trigger level /V:	1	1	
Antenna cable maker and type: Phase stabilised cable (Y/N):	RG-214 (N)	Times Microwave Systems LMR-400-UF (N)	
Length outside the building /m:	ca. 5	ca. 30	
Antenna maker and type: Antenna serial number:	Javad RingAnt-G3T 453	Navexperience 3G+C NA0164	
Temperature (if stabilised) /°C			
<b>Measured delays /ns</b>			
	<b>Local:</b>	<b>Travelling:</b>	
Delay from local UTC to receiver PPS-in ( $X_p$ ) / ns	15.4	44.2	
Delay from 1 PPS-in to internal Reference (if different) ( $X_0$ ) / ns		N/A	
Antenna cable delay ( $X_C$ ) / ns	404	266.5	
Splitter delay (if any) / ns			
Additional cable delay (if any) / ns			
<b>Data used for the generation of CCGTTS files</b>			
	<b>LOCAL:</b>	<b>Travelling</b>	
<input type="checkbox"/> INT DLY (or $X_R+X_S$ ) (GPS) /ns:	-20.2 (LC1) -20.45 (LC2) -19.25 (LP1) -19.01 (LP2)	-42.6 (P1) -49.1 (P2)	
<input type="checkbox"/> INT DLY (or $X_R+X_S$ ) (GLONASS) /ns:	-224.95 (LC1) -259.95 (LC2) -224.97 (LP2) -257.67 (LP2)		
<input type="checkbox"/> CAB DLY (or $X_C$ ) /ns:	404	266.5	
<input type="checkbox"/> REF DLY (or $X_p+X_0$ ) /ns:	15.4	44.2	
<input type="checkbox"/> Coordinates reference frame:	ITRF	ITRF	
X /m:	+ 4087027.30	+4087027.14	
Y /m:	+ 1196557.37	+1196560.85	
Z /m	+ 4732637.05	+4732635.89	
<b>General information</b>			
<input type="checkbox"/> Rise time of the local UTC pulse:	1.8 ns		

<input type="checkbox"/> Is the laboratory air conditioned:	yes
Set temperature value and uncertainty:	23 °C ± 0,5 °C

## UPDATED

Names of files to be used in processing (for site BEV)

Local receiver: GZBE1NMJ.DDD, produced by PTB

Travelling receiver GZPTBTMJ.DDD

- Comments: New REF DLY, new antenna coordinates

<b>Laboratory:</b>		<b>BEV</b>	
Date and hour of the beginning of measurements:	2016-06-17 14:26 UTC (MJD 57556)		
Date and hour of the end of measurements:	2016-06-22 08:50 UTC (MJD 57561)		
<b>Information on the system</b>			
	<b>Local:</b>	<b>Travelling:</b>	
4-character BIPM code	<b>BE3_</b>	<b>PTBT</b>	
Receiver maker and type:	Dicom GTR51	Dicom GTR50	
Receiver serial number:	1603002	0708522 1.7.4	
1 PPS trigger level /V:	1	1	
Antenna cable maker and type: Phase stabilised cable (Y/N):	unknown (N)	Times Microwave Systems LMR-400-UF (N)	
Length outside the building /m:	ca. 5	ca. 30	
Antenna maker and type: Antenna serial number:	Novatel GPS-703-GGG 01018146	Navexperience 3G+C NA0164	
Temperature (if stabilised) /°C			
<b>Measured delays /ns</b>			
	<b>Local:</b>	<b>Travelling:</b>	
Delay from local UTC to receiver PPS-in ( $X_p$ ) / ns	15.3	44.2	
Delay from 1 PPS-in to internal Reference (if different) ( $X_o$ ) / ns		N/A	
Antenna cable delay ( $X_c$ ) / ns	262.1	266.5	
Splitter delay (if any) / ns			
Additional cable delay (if any) / ns			
<b>Data used for the generation of CGGTTS files</b>			
	<b>LOCAL:</b>	<b>Travelling</b>	
<input type="checkbox"/> INT DLY (or $X_R+X_S$ ) (GPS) /ns:	-27.2 (LC1) 0 (LC2) -33.4 (LP1) -35.5 (LP2)	-42.6 (P1) -49.1 (P2)	
<input type="checkbox"/> INT DLY (or $X_R+X_S$ ) (GLONASS) /ns:	0 (LC1) 0 (LC2) 0 (LP2) 0 (LP2)		
<input type="checkbox"/> CAB DLY (or $X_c$ ) /ns:	262.1	266.5	
<input type="checkbox"/> REF DLY (or $X_p+X_o$ ) /ns:	15.3	44.2	
<input type="checkbox"/> Coordinates reference frame:	ITRF	ITRF	
X /m:	+4087025.73	<b>+4087027.14</b>	
Y /m:	+1196557.61	<b>+1196560.85</b>	
Z /m	+4732639.99	<b>+4732635.89</b>	
<b>General information</b>			
<input type="checkbox"/> Rise time of the local UTC pulse:	1,8 ns		
<input type="checkbox"/> Is the laboratory air conditioned:	yes		
Set temperature value and uncertainty:	23 °C ± 0,5 °C		

**UPDATED**



Names of files to be used in processing (for site BEV)

Local receiver: GZBE3NMJ.DDD, produced by PTB

Travelling receiver GZPTBTMJ.DDD

Comments: New coordinates

## Second common clock measurement at PTB

<b>Laboratory:</b>		<b>PTB</b>	
Date and hour of the beginning of measurements:		2016-07-06 0:00 UTC (MJD 57575)	
Date and hour of the end of measurements:		2016-07-12 24:00 UTC (MJD 57581)	
<b>Information on the system</b>			
	<b>Local:</b>	<b>Travelling:</b>	
4-character BIPM code	<b>PTBB</b>	<b>PTBT</b>	
Receiver maker and type:	ASHTECH Z-XII3T	Dicom GTR50	
Receiver serial number:	(S/N RT820013901)	0708522 1.7.4	
1 PPS trigger level /V:	1 V	1	
Antenna cable maker and type: Phase stabilised cable (Y/N):	Nokia RG214	Times Microwave Systems LMR-400-UF (N)	
Length outside the building /m:	approx. 25m	25	
Antenna maker and type: Antenna serial number:	Ashtech ASH700936 SNOW (S/N CR15930)	Navexperience 3G+C NA0164	
Temperature (if stabilised) /°C			
<b>Measured delays /ns</b>			
	<b>Local:</b>	<b>Travelling:</b>	
Delay from local UTC to receiver 1 PPS-in ( $X_p$ ) 7 ns	20.1 ± 0.1 (*)	47.2 ± 0.1 (**)	
Delay from 1 PPS-in to internal Reference (if different): ( $X_o$ ) / ns	38.0 ± 0.1	N/A	
Antenna cable delay: ( $X_c$ ) / ns	301.7	266.5 ± 0.1 (**)	
Splitter delay (if any):	N/A		
Additional cable delay (if any):	N/A		
<b>Data used for the generation of CGGTTS files</b>			
	<b>LOCAL:</b>	<b>Travelling</b>	
<input type="checkbox"/> INT DLY (or $X_R+X_S$ ) (GPS) /ns:	303.9 (P1), 319.3 (P2)	-42.6 (P1) -49.1 (P2)	
<input type="checkbox"/> INT DLY (or $X_R+X_S$ ) (GLONASS) /ns:			
<input type="checkbox"/> CAB DLY (or $X_c$ ) /ns:	301.7	266.5	
<input type="checkbox"/> REF DLY (or $X_p+X_o$ ) /ns:	74.0 (*)	47.2	
<input type="checkbox"/> Coordinates reference frame:	ITRF (*)	ITRF (***)	
X /m:	+3844059.89 (*)	Mast P10	+3844056.64
Y /m:	+709661.48 (*)		+709664.25 (***)
Z /m:	+5023129.73 (*)		+5023131.88 (***)
			Mast P13
<b>General information</b>			
<input type="checkbox"/> Rise time of the local UTC pulse:	3 ns		
<input type="checkbox"/> Is the laboratory air conditioned:	yes		
Set temperature value and uncertainty:			

Notes:

(\*) values provided by BIPM as part of coordinate alignment 2014 and G1 calibration  
Ca\_Id=1001-2014

(\*\*) Use of the same counter and receiver throughout the campaign suppresses major systematic uncertainty contributions

(\*\*\*) INT DLY adjusted after publication of results Ca\_Id=1001-2014, coordinates interpolated from BIPM results for neighbouring masts

Names of files to be used in processing for site PTB CC2

Local receiver: GZPT02MJ.DDD

Travelling receiver GZPTBMJ.DDD

END of DOCUMENT